

Specification

- Part No. : **CA.51**
- Product Name : DSRC / V2V / V2X / V2I
5900MHz Ceramic Chip Antenna
- Feature : Stable and Reliable Performance
1.6*0.8*0.3mm
Linear Polarized
Low Profile
High Efficiency
Peak Gain 2dBi
Compact Size
SMD Mount
RoHS Compliant





1. Introduction

The Taoglas CA.51 5850-5925 MHz ceramic chip antenna is specifically designed for IEEE 802.11p / DSRC applications. It is a high efficiency miniature SMT ceramic antenna with a small footprint requirement. This ceramic chip antenna uses the main PCB as its ground plane, thereby increasing antenna efficiency and decreasing the assembly cost. It is tuned for different PCB sizes by simply changing the value of the matching circuit.

At 1.6mm*0.8mm*0.3mm, it is one of the smallest antennas available worldwide. This antenna is delivered on tape and reel.

Applications

IEEE 802.11p (WAVE- Wireless Access in the Vehicular Environment)

DSRC (Dedicated Short Range Communication) systems for V2V / V2I / V2X



2. Specification Table

Electrical Characteristics*	
Operation Frequency Band	5850~5925 MHz
Bandwidth	110 MHz (typical)
Peak Gain	2.87 dBi (typical)
Efficiency	57.08% (typical)
Average Gain	-2.44 dBi
VSWR	2 max.
Impedance	50Ω
Polarization	Linear
Radiation Pattern	Omni-Directional
Input Power	2W
MECHANICAL	
Dimensions	1.6*0.8*0.3mm
Ground plane	40*40mm (Recommended)
Material	Ceramic
ENVIRONMENTAL	
Temperature Range	-40°C to 85°C
Temperature Coefficient of Frequency	0±20 ppm/°C max. (@-40°C to 85°C)
Humidity	Non-condensing 65°C 95% RH

*Antenna tested on 40mm*40mm evaluation board.

3. Return Loss

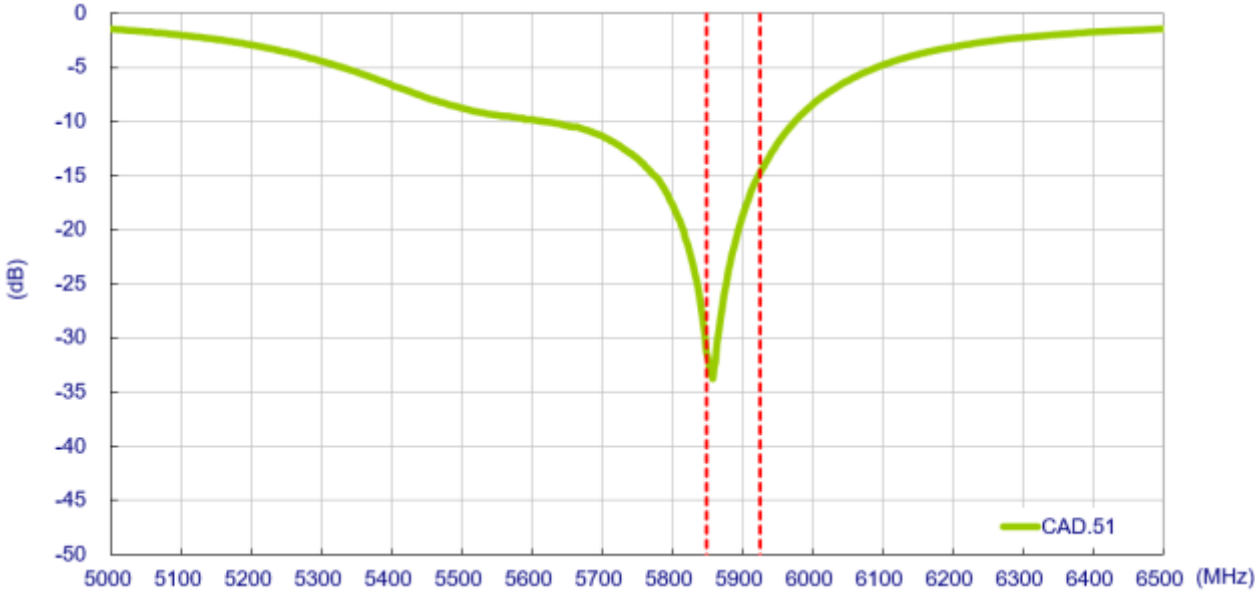

4. Efficiency

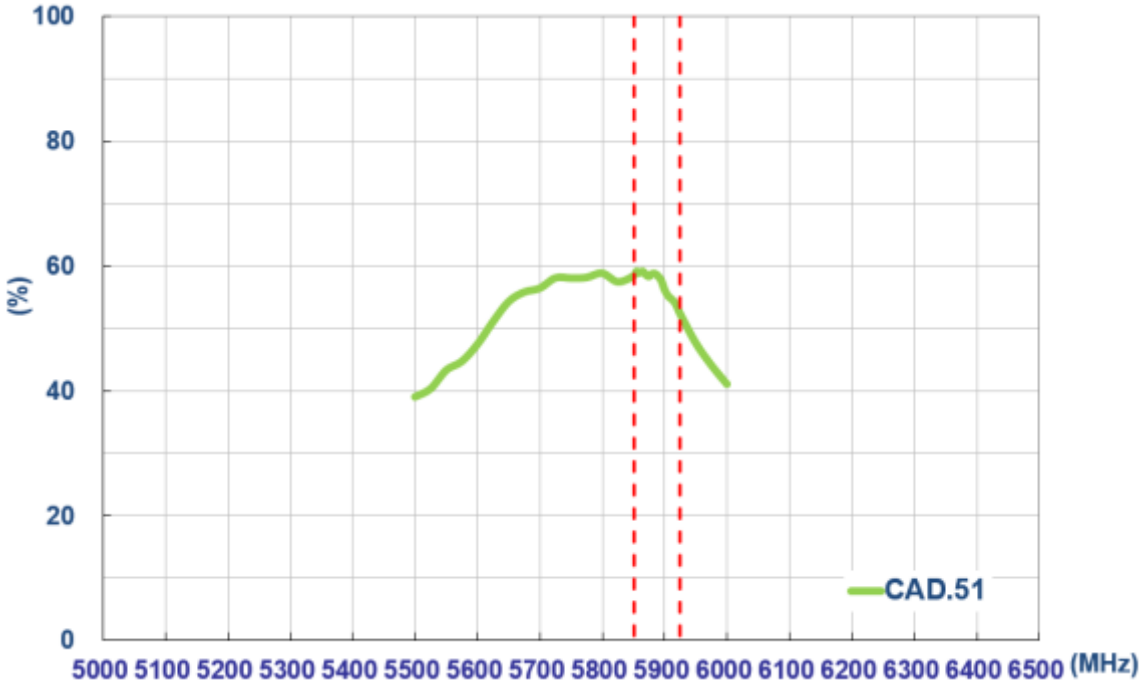

5. Average Gain

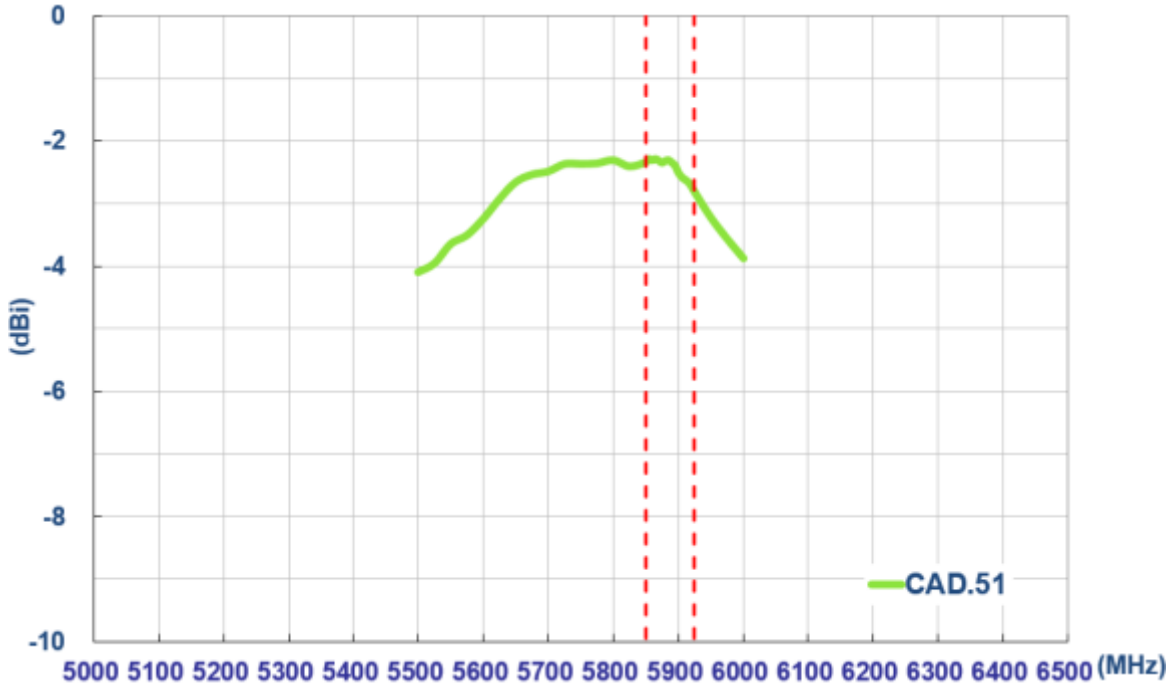

6. Peak Gain

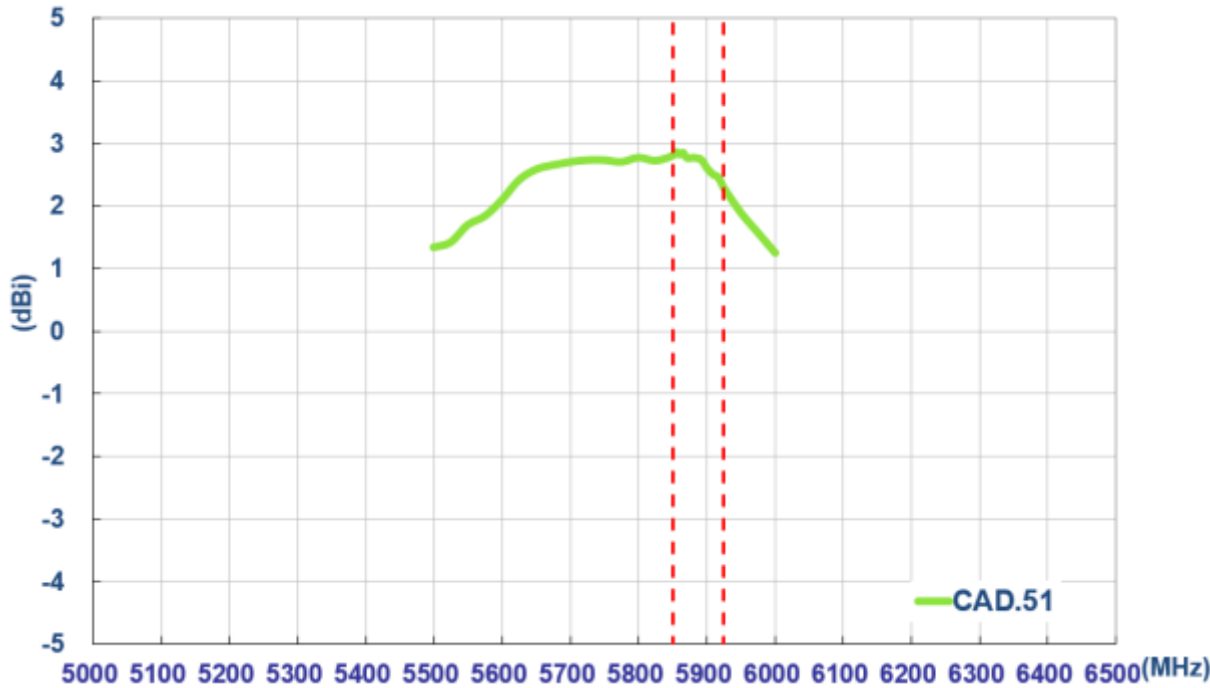

7. Antenna Radiation Patterns

7.1. Test Setup – Antenna on Evaluation Board



7.2. 2D Radiation Pattern

XY Plane

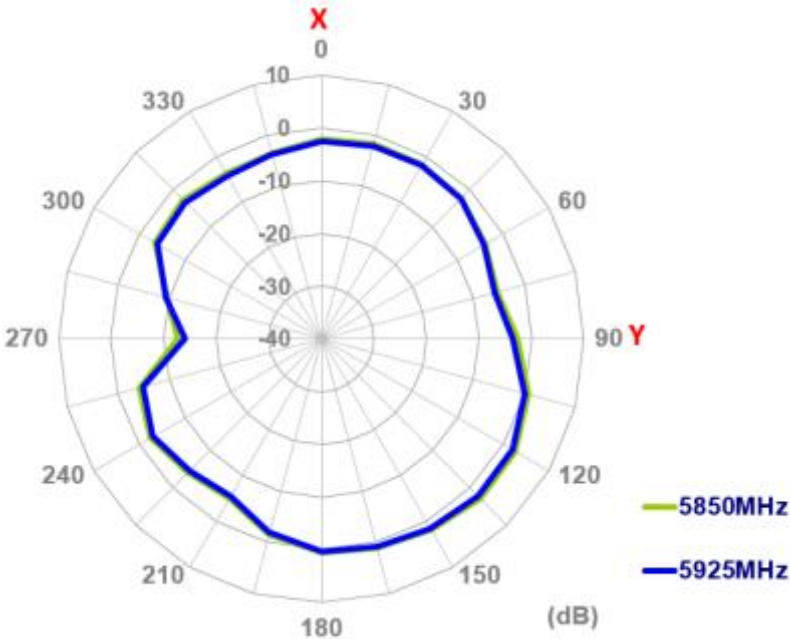

XZ Plane

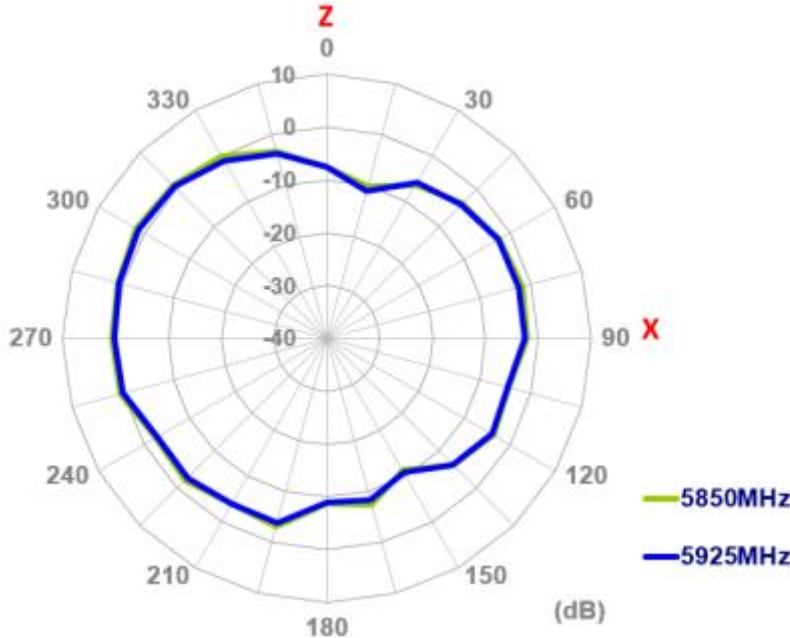

YZ Plane

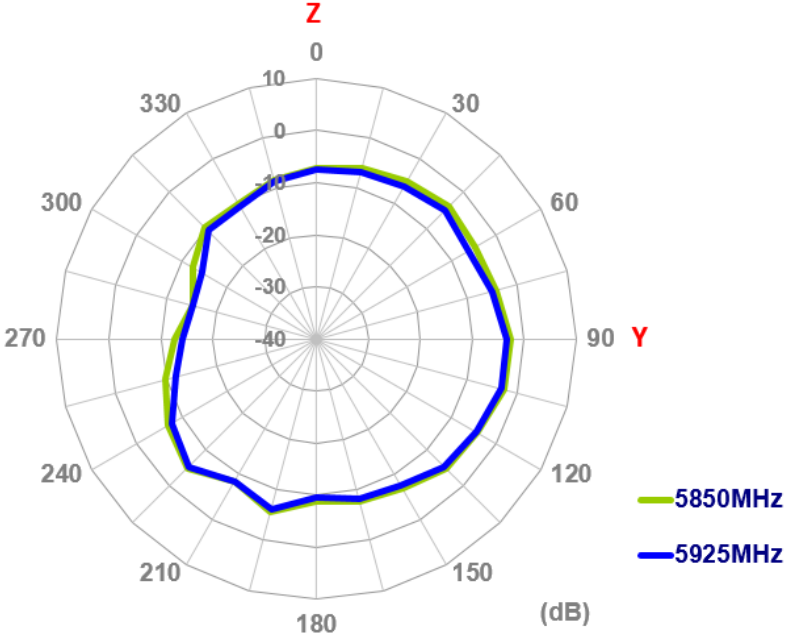

7.3. 3D Radiation Pattern

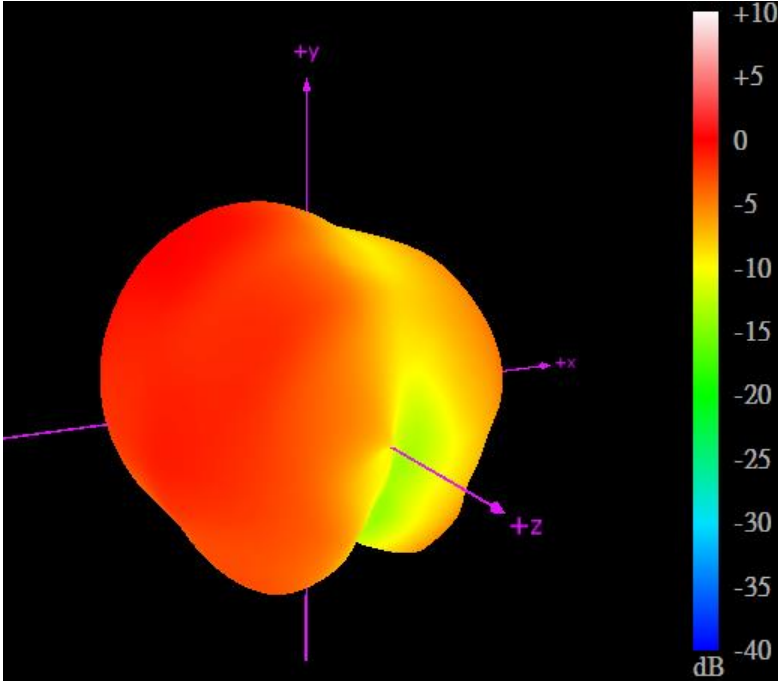

5850MHz

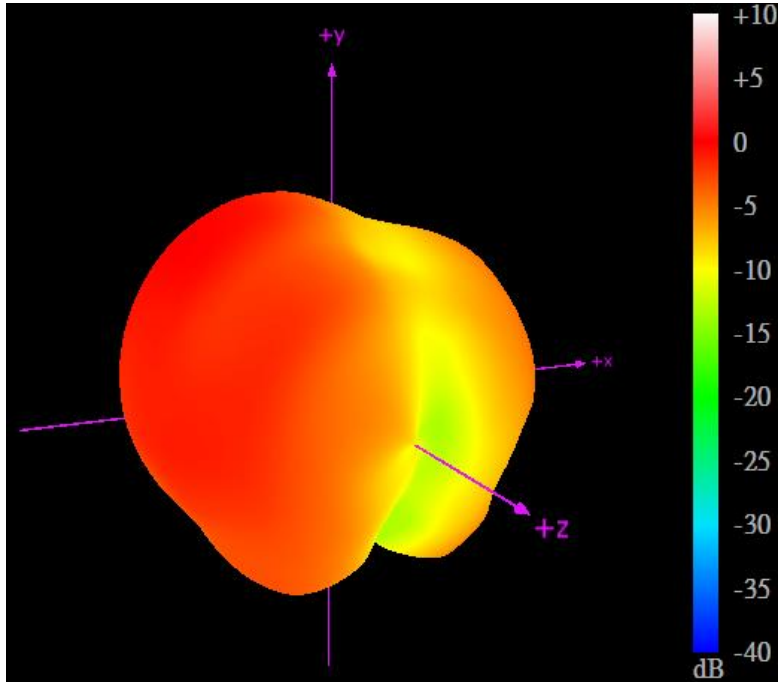

5925MHz

8. Mechanical Drawings (Unit: mm)

8.1. Antenna Dimension and Drawing

Front View

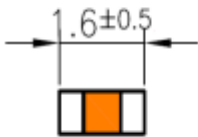

Side View

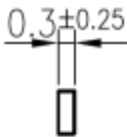

Back View

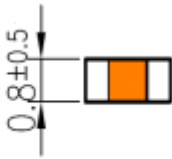

Unit: mm

8.2. Antenna Footprint

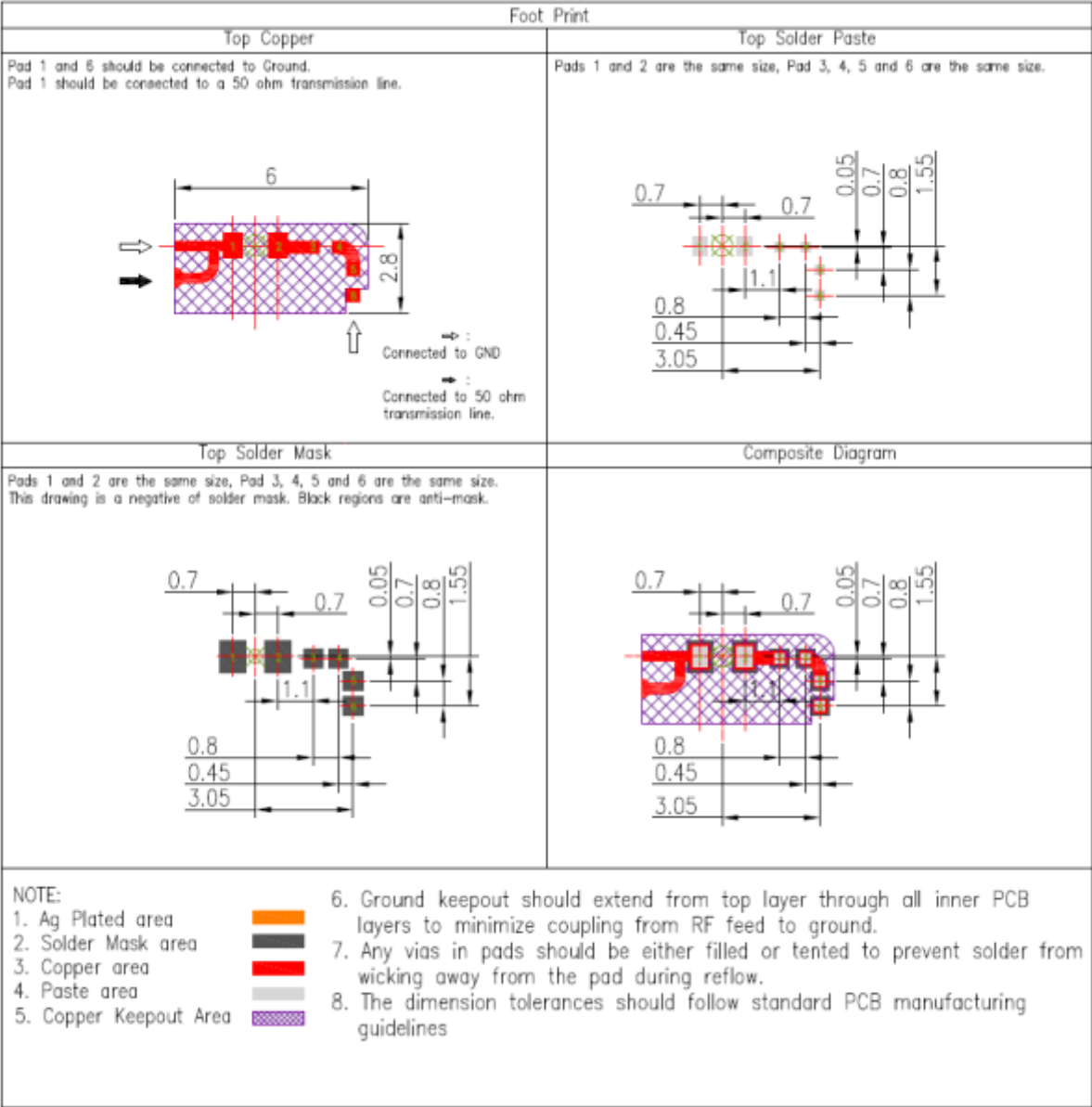

*Taoglas is able to provide CAD drawing file to customers for evaluation.

8.3. Evaluation Board CAD.51

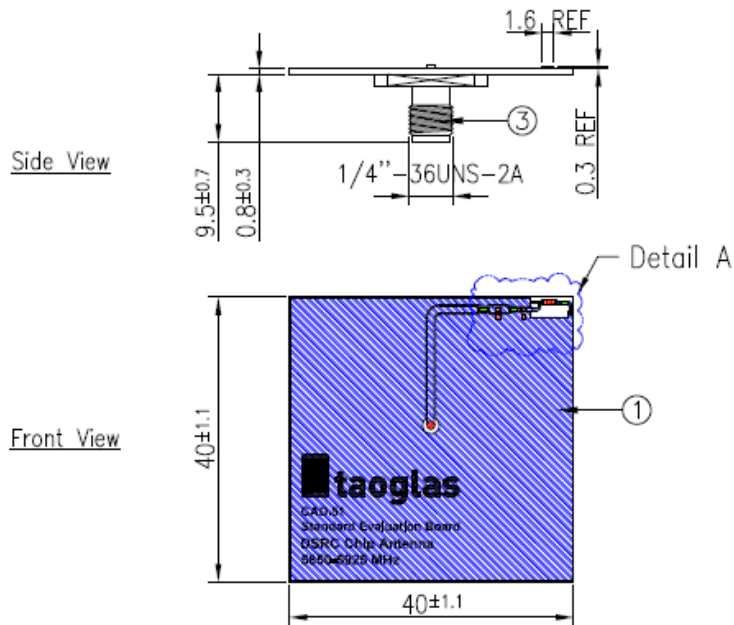

Unit: mm

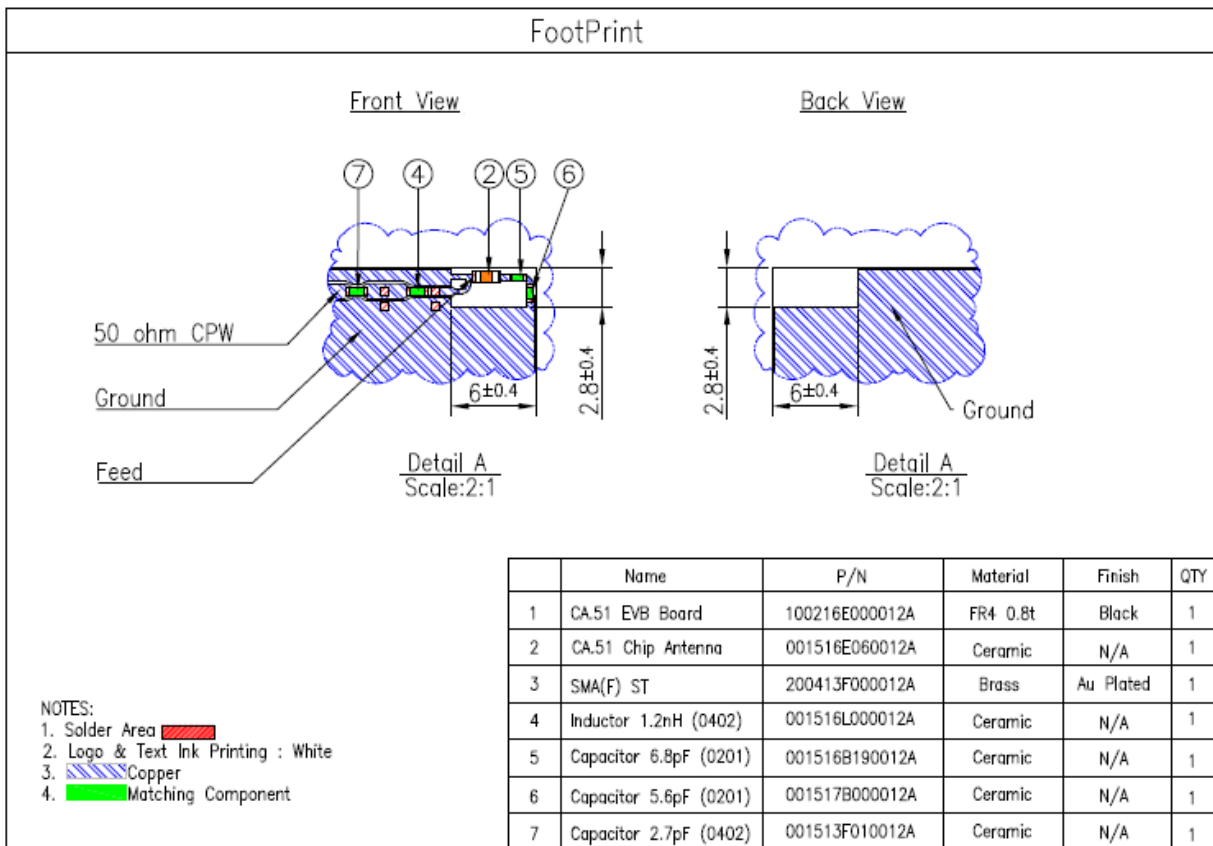

9. Soldering Conditions

Typical Soldering profile for lead-free process:

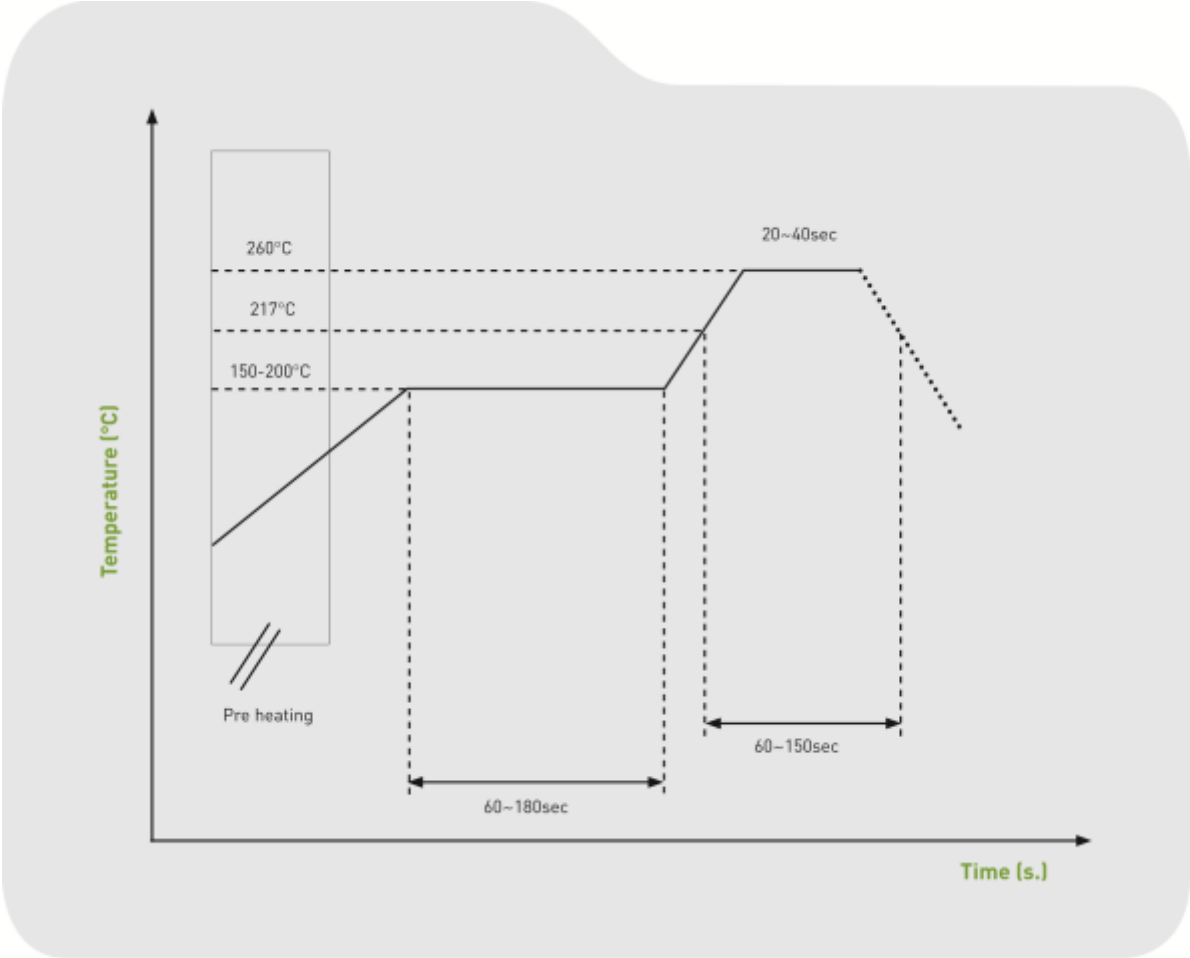

10. Packaging

5000 pc CA.51 per reel
 Dimensions - Ø180*11mm
 Weight - 159.8g

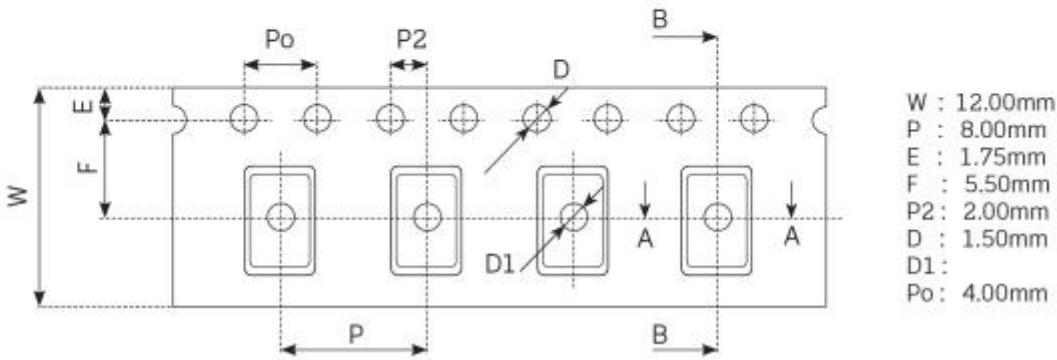
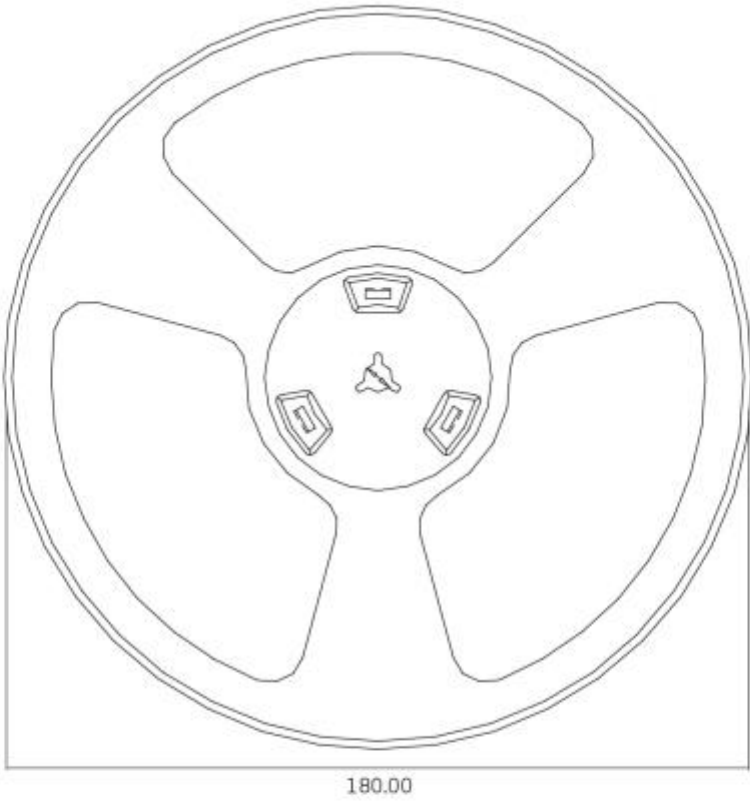



5000 pcs CA.51 reel
 Dimensions - 180*180*11mm
 Weight - 159.8g

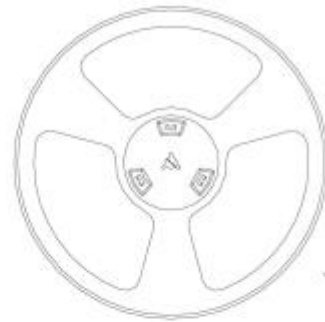

50,000 pcs CA.51 / 10 Reel in small box
 Dimensions - 193*225*195mm
 Weight - 1.6Kg

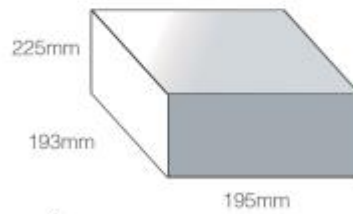

2 small boxes, 100,000 pcs in one carton
 Carton Dimensions - 247*405*225mm
 Weight - 3.2Kg

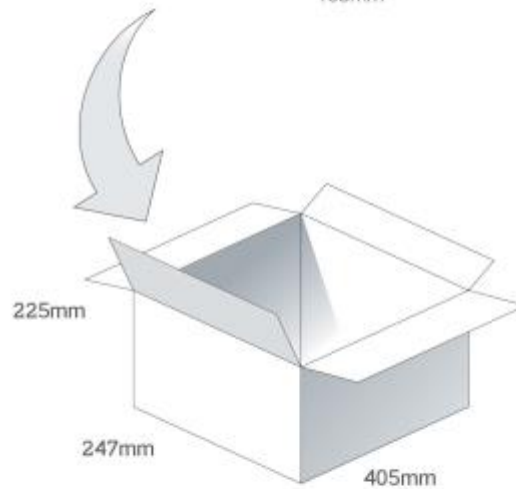

Pallet Dimensions 1200*1000*1310mm
 40 Cartons per Pallet
 8 Cartons per layer
 5 Layers

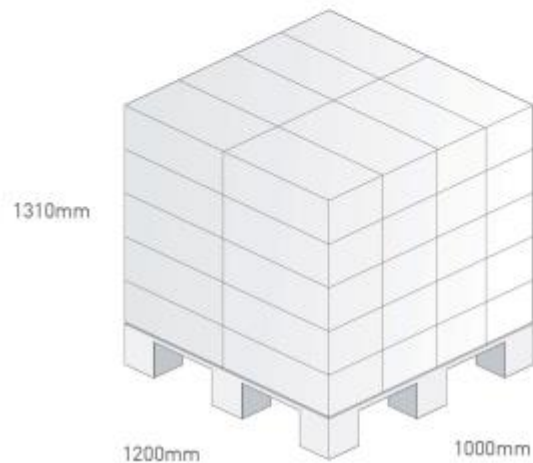



Taoglas makes no warranties based on the accuracy or completeness of the contents of this document and reserves the right to make changes to specifications and product descriptions at any time without notice. Taoglas reserves all rights to this document and the information contained herein.

Reproduction, use or disclosure to third parties without express permission is strictly prohibited.

Copyright © Taoglas Ltd.