

HDSM-431W/433W

0.39 inch (10.0 mm)

Single-Digit Surface Mount LED Display



Data Sheet

Description

This is 0.39" (10.0 mm) height single-digit display. This device utilizes white ChipLED. This device comes with top surface gray and white segments.

White	Description
HDSM-431W	Common Anode, Right Hand Decimal
HDSM-433W	Common Cathode, Right Hand Decimal

Features

- 0.39" digit height
- Low current operation
- Excellent characters appearance
- Available in CA and CC
- 1000 pieces per reel
- Moisture Sensitivity Level: Level 3
- RoHS compliant

Package Dimensions

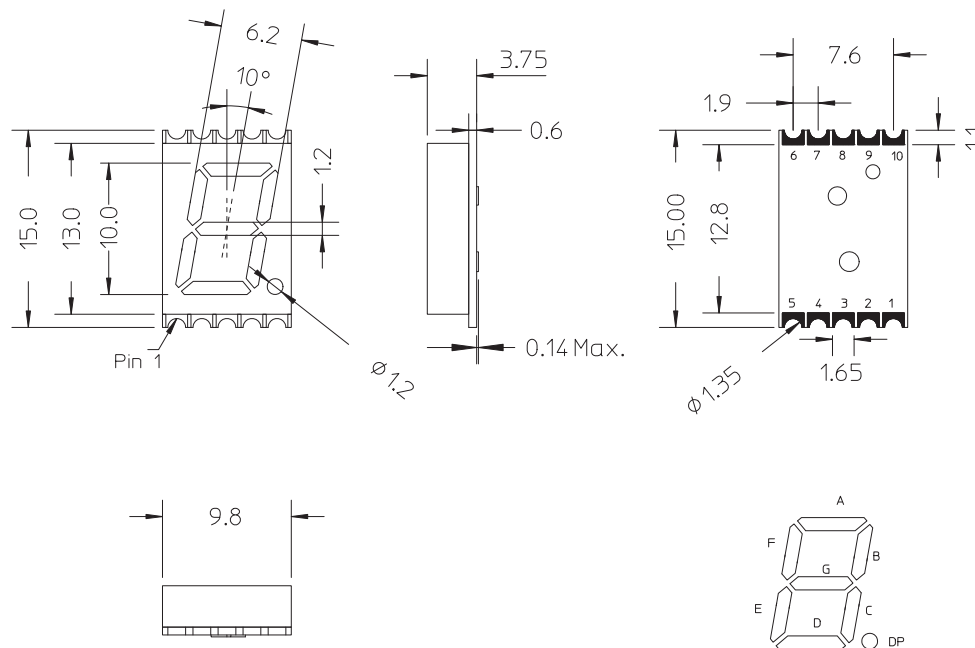

Note:

1. All dimensions are in millimeters.
2. Tolerance is ± 0.25 mm (0.01"), unless otherwise specified.

CAUTION: LEDs are Class 1A ESD sensitive per JESD22-A114C.01.
Please observe appropriate precautions during handling and processing.

Pin Connection (Common Anode)

Pin No.	Connection
1	CATHODE E
2	CATHODE D
3	COMMON ANODE
4	CATHODE C
5	CATHODE DP
6	CATHODE B
7	CATHODE A
8	COMMON ANODE
9	CATHODE F
10	CATHODE G

Pin Connection (Common Cathode)

Pin No.	Connection
1	ANODE E
2	ANODE D
3	COMMON CATHODE
4	ANODE C
5	ANODE DP
6	ANODE B
7	ANODE A
8	COMMON CATHODE
9	ANODE F
10	ANODE G

Internal Circuit Diagram (Common Anode)

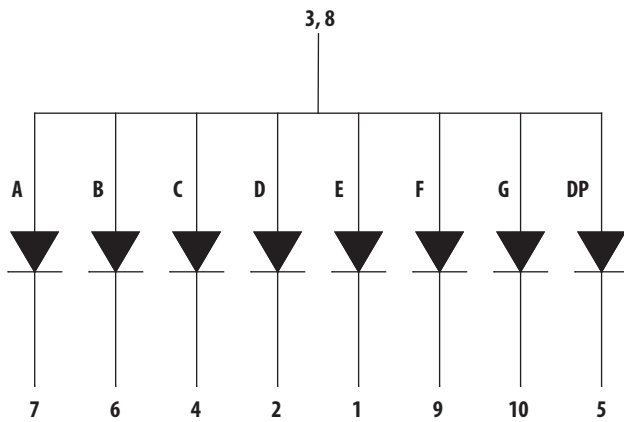

Internal Circuit Diagram (Common Cathode)

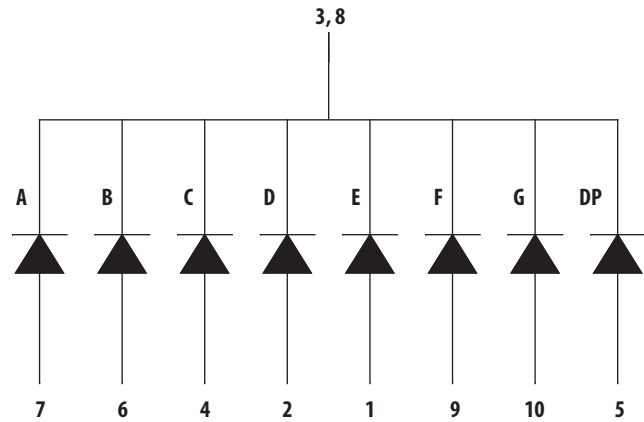

Absolute Maximum Ratings @ $T_A = 25\text{ }^\circ\text{C}$

Parameter	White	Unit
Power Dissipation Per Segment	39	mW
Peak Forward Current Per Segment (1/10 Duty Cycle, 0.1 ms pulse width)	80	mA
Continuous Forward Current Per Segment Derating Linearly From 25 °C Per Segment	10 0.083	mA Z
Reverse Voltage Per Segment	Not designed for reverse bias	V
Operating Temperature Range	-40 °C to +85 °C	°C
Storage Temperature Range	-40 °C to +85 °C	°C

Electrical / Optical Characteristics @ $T_A = 25\text{ }^\circ\text{C}$ **White**

Parameter	Symbol	Min.	Typ.	Max.	Unit	Test Condition
Average Luminous Intensity	I_V	24	40	–	mcd	$I_F = 5\text{ mA}$
Chromaticity Coordinates	(x,y)		See Figure 1			$I_F = 5\text{ mA}$
Forward Voltage, Per Segment	V_F	–	2.95	3.8	V	$I_F = 5\text{ mA}$
Reverse Current, Per Segment ^[1]	I_R	–	–	100	μA	$V_R = 5\text{ V}$
Luminous Intensity Matching Ratio	I_{V-m}	–	–	2:1	–	$I_F = 5\text{ mA}$

Note 1. Indicates production final test condition only. Long term reverse biasing is not recommended.

Typical Electrical / Optical characteristic Curves @ $T_A = 25^\circ\text{C}$

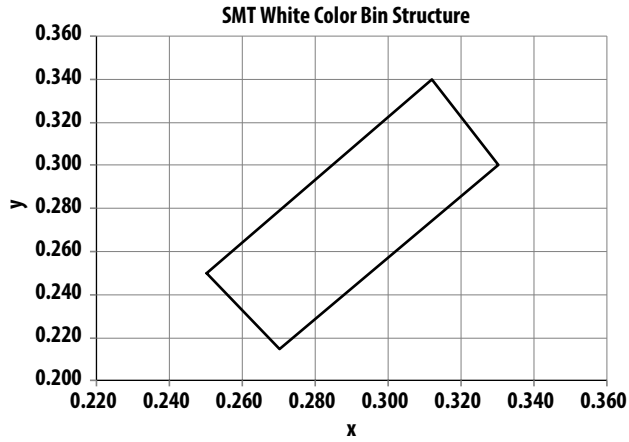

Chromaticity Coordinates				
x	0.250	0.270	0.330	0.312
y	0.250	0.215	0.300	0.340

Figure 1. Color bin limit (CIE 1931 Chromaticity Diagram) [Tolerance: ± 0.02]

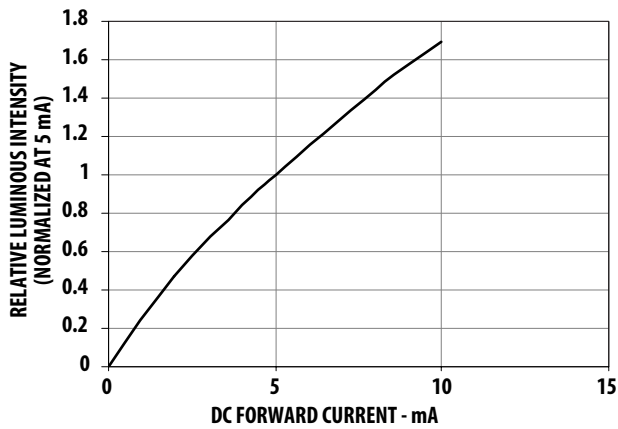

Figure 2. Relative luminous intensity versus forward current

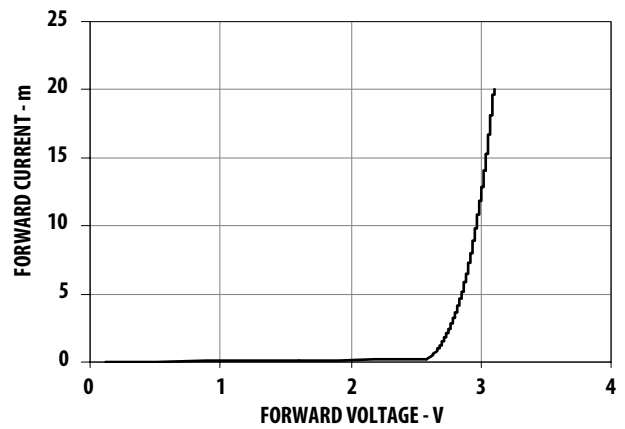

Figure 3. Forward current versus forward voltage

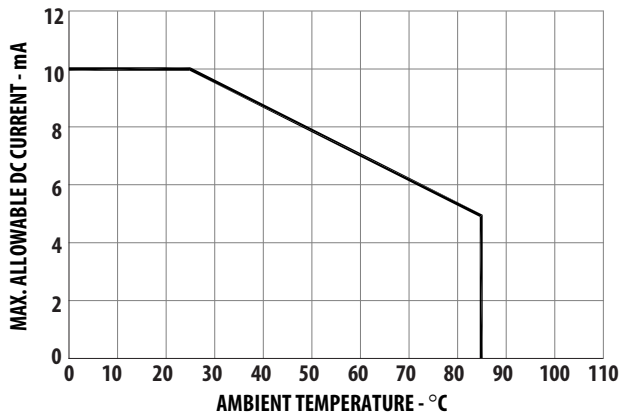
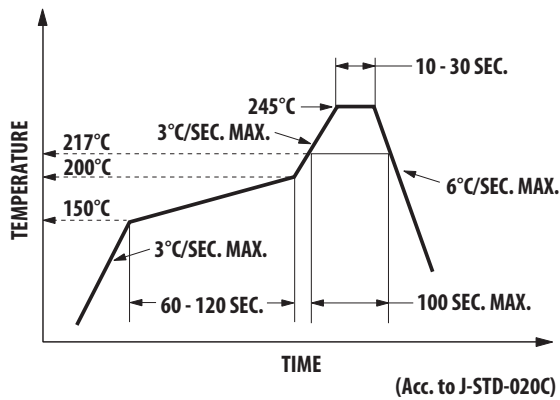

Figure 4. Allowable DC Current Versus Ambient Temperature

SMT Soldering Profile

Pb free reflow soldering Profile



Notes:

1. The peak temperature refers to the peak package body temperature.
2. Number of reflow process shall be limited to maximum 2 times only. Cooling process to normal temperature is required between first and second soldering process.

Recommended Soldering Pattern (unit: mm)

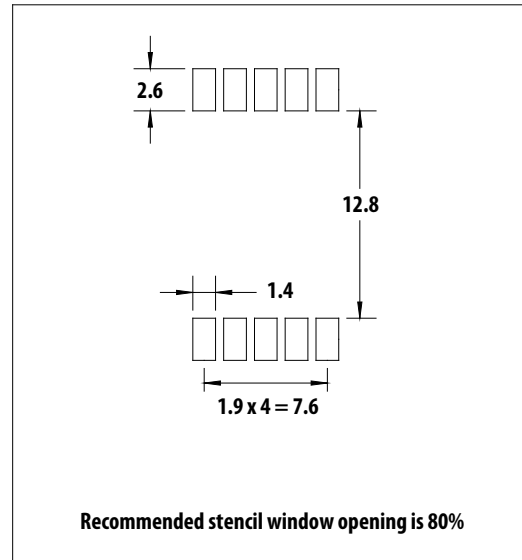

Tape Specification (unit: mm)

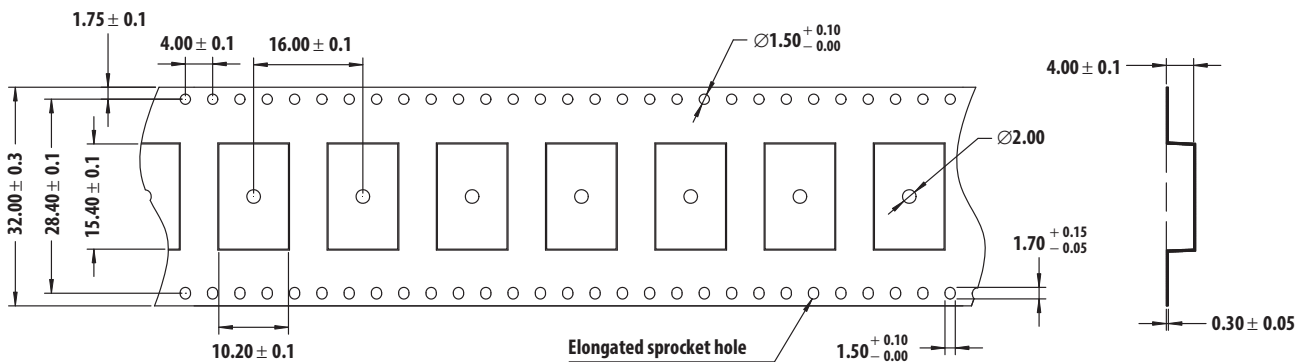

For product information and a complete list of distributors, please go to our web site: www.avagotech.com

Avago, Avago Technologies, and the A logo are trademarks of Avago Technologies in the United States and other countries. Data subject to change. Copyright © 2005-2014 Avago Technologies. All rights reserved. AV02-1644EN - November 20, 2014

