

**Product :**  
0.56 " SINGLE DIGIT DISPLAY

**Part Number :**  
VAOS-C561G9-BW/43  
VAOS-A561G9-BW/43

**Description**

Chip Material-G: GaP/GaP.  
Emitted Color: Yellow Green.  
Black Face & White Segment.

VAOS-C561G9-BW/43  
Common Cathode.

VAOS-A561G9-BW/43  
Common Anode.

Absolute Maximum Ratings at Ta=25°C

Parameter	Symbol	Yellow Green	Unit
Power dissipation per dice	PAD	70	mW
Derating Liner from 25°C per dice	-	0.33	mA°C
Continuous forward current per dice	IAF	25	mA
Peak current per dice (duty cycle 1/10, 1kHz)	IPF	90	mA
Reverse voltage per dice	VR	5	V
Operating temperature	Topr	-25 to +85	°C
Storage temperature	Tstg	-25 to +85	°C
Solder temperature 1/16 inch below seating plane for 5 seconds at 260°C			

Electrical / Optical Characteristics and Curves at Ta=25°C

Parameter	Symbol	Test Condition	Min.	Typ.	Max.	Unit
Forward Voltage per segment	VF	IF=20 mA		2.1	2.8	V
Luminous intensity per segment	IV	IF=20 mA		9.1		mcd.
Peak emission wavelength	$\lambda d$	IF=20 mA		565		nm
Spectrum radiation bandwidth	$\Delta \lambda$	IF=20 mA		30		Deg.
Reverse Current	IR	VR=5 V			100	$\mu A$

\* Tolerance :  $\pm 20\%$ .

## Package Dimension & Internal Circuit

- \* 0.56 inch (14.2mm) Digit height.
- \* Case mold type.
- \* Excellent character appearance.
- \* Wide viewing angle.

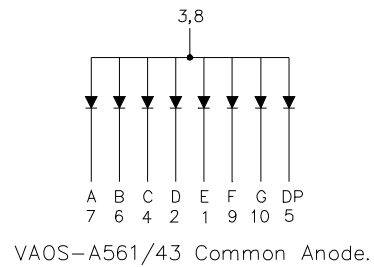
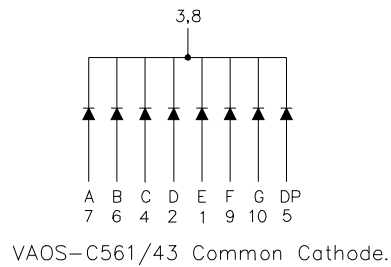
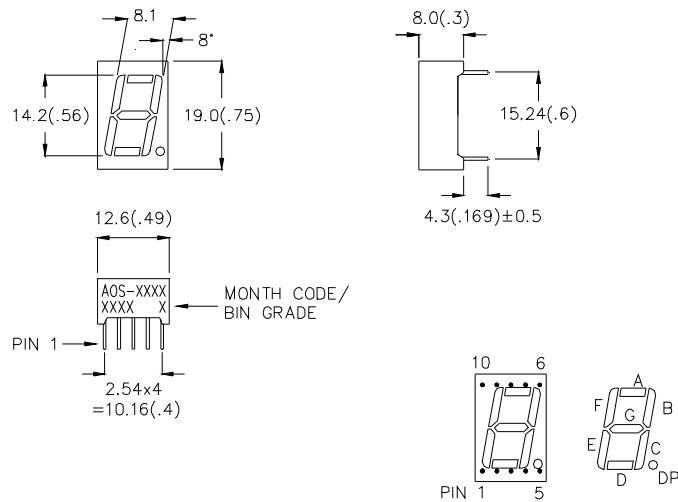

**NOTE:**

1. All pins are  $\varnothing 0.51(.02)$ .
2. Dimension in millimeter (inch), and tolerance is  $\pm 0.30 (.01)$  unless otherwise noted.

VER\_A-08-10-P43



# GREEN

## Typical Electro-optical Characteristic Curves (25°C Free Air Temperature Unless Otherwise Specified)

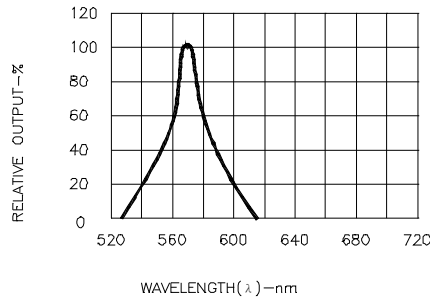

Fig.1 SPECTRAL RESPONSE

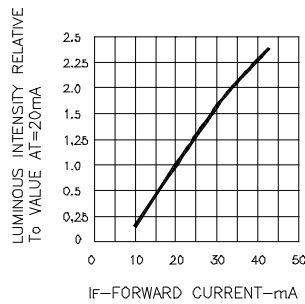

Fig.2 RELATIVE LUMINOUS INTENSITY VS. FORWARD CURRENT

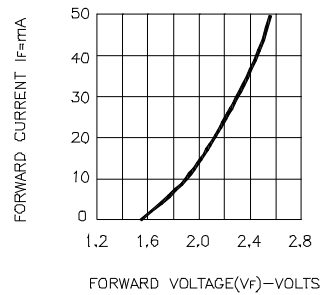

Fig.3 FORWARD CURRENT VS FORWARD VOLTAGE

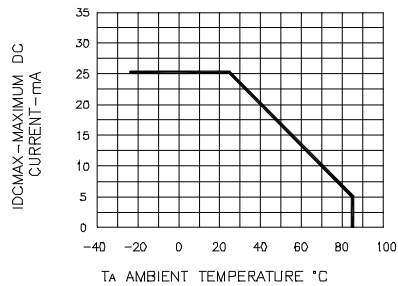

Fig.4 MAXIMUM ALLOWABLE DC CURRENT PER SEGMENT VS. AMBIENT TEMPERATURE

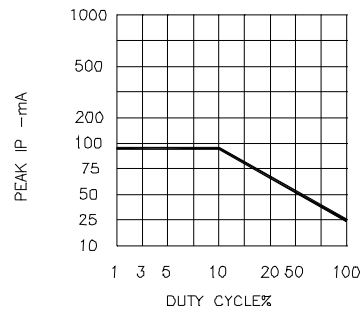

Fig.5 MAX PEAK CURRENT VS. DUTY CYCLE % (REFRESH RATE f=1KHz)