

**WARRANTY
REGISTRATION**
Register online today for
a chance to win a FREE Tripp Lite
product! www.tripplite.com/warranty



Owner's Manual

PowerVerter® Plus

DC-to-AC Inverter

Input	Output
12 VDC	120V, 60 Hz. AC



1111 W. 35th Street, Chicago, IL 60609 USA
Customer Support: (773) 869-1234
www.tripplite.com



Reliable AC Power Wherever You Need It!

Congratulations! You've purchased the most advanced, feature-rich Inverter designed as a mobile energy source for your vehicle. PowerVerter Inverters efficiently convert DC (battery) power into 120V AC (household) power, allowing you to use equipment you commonly use at home—appliances, entertainment systems, computers, power tools and more—while cruising the open road. PowerVerter Inverters, through a high-efficiency conversion process and a charge conservation setting, draw the highest level of performance from your batteries without overtaxing them, lengthening their service life. An automatic low battery shutdown feature ensures you'll always have plenty of power for starting purposes.

- **Automatic Overload Protection**
- **Automatic "Battery-Saver" Low Voltage Shutdown**
- **High Efficiency DC-to-AC Inversion**
- **Multi-Function Lights and Switches**
- **Optional Remote Control Capability**
- **Frequency-Controlled Output**
- **Moisture-Resistant Construction***
- **Battery Charge Conserver (Load Sense)**

Contents

Important Safety Instructions	2	Mounting	6
Feature Identification	2	Battery Connection & Cable Sizing Chart	6
Operation	3	AC Output Connection	7
Application Guide	5	Service/Maintenance	8
		Troubleshooting	8
		Warranty/Warranty Registration	8

Important Safety Instructions



SAVE THESE INSTRUCTIONS!

This manual contains important instructions and warnings that should be followed during the installation, operation and storage of this product.

Location Warnings

- Although your Inverter is moisture resistant, it is NOT waterproof. Flooding the unit with water will cause it to short circuit and could cause personal injury due to electric shock. Never immerse the unit, and avoid any area where standing water might accumulate. Mounting should be in the driest location available. The Inverter must be shielded from outside weather conditions.
- Leave a minimum of 2" clearance at front and back of the Inverter for proper ventilation. To avoid automatic Inverter shutdown due to excessive heat, any compartment that contains the Inverter must be properly ventilated with adequate outside air flow. The heavier the load of connected equipment, the more heat will be generated by the unit.



Caution: If your Inverter/Charger is mounted in a location that lacks proper ventilation, the surface of the metal enclosure could become hot. Allow to cool before touching. If the Inverter/Charger must be installed in a location that lacks proper ventilation, mount the unit in such a way that the top of the metal enclosure will not be subjected to accidental contact during operation.

- Do not install the Inverter directly near magnetic storage media, as this may result in data corruption.
- Do not install the Inverter near flammable materials, fuel or chemicals.

Battery Connection Warnings

- The Inverter will not operate until batteries are connected.
- Multiple battery systems must be comprised of batteries of identical voltage, age, amp-hour capacity and type.
- Because explosive hydrogen gas can accumulate near batteries if they are not kept well ventilated, your batteries should not be installed (whether for a mobile or stationary application) in a "dead air" compartment. Ideally, any compartment would have some ventilation to outside air.
- Sparks may result during final battery connection. Always observe proper polarity as batteries are connected.
- Do not allow objects to contact the two DC input terminals. Do not short or bridge these terminals together. Serious personal injury or property damage could result.

Equipment Connection Warnings

Do not use a Tripp Lite Inverter in life support or healthcare applications where a malfunction or failure of a Tripp Lite Inverter could cause failure of, or significantly alter the performance of, a life support device or medical equipment.

- You may experience uneven performance results if you connect a surge suppressor, line conditioner or UPS system to the output of the Inverter.
- The main grounding lug should be connected to the vehicle chassis with an 8 AWG wire (minimum).

Operation Warnings

- Your Inverter does not require routine maintenance. Do not open the device for any reason. There are no user serviceable parts inside.
- Potentially lethal voltages exist within the Inverter as long as the battery is connected. During any service work, the battery supply should be disconnected.
- Do not connect or disconnect batteries while the Inverter is operating. Dangerous arcing may result. Operating Mode Switch should be in the OFF position.

Feature Identification (continued)

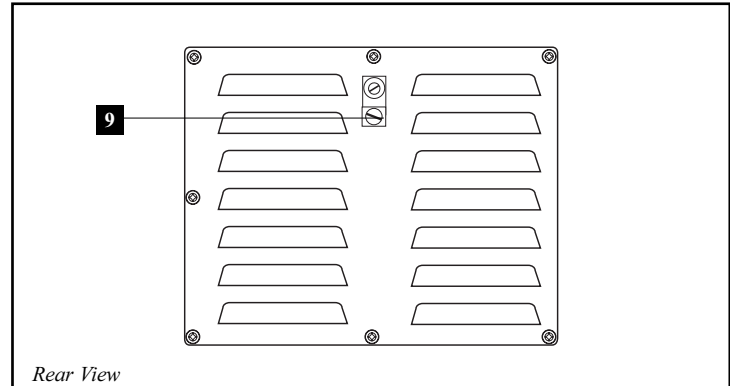
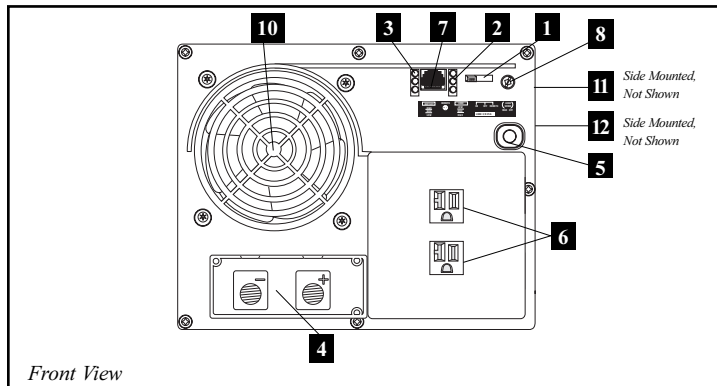

Identify the premium features on your specific model and quickly locate instructions on how to maximize their use.

1 ON-OFF-REMOTE Switch:

- Move the switch to the ON position to have your Inverter provide connected equipment with AC power by converting DC power from an attached battery.
- Leave the switch in the OFF position when not using connected equipment to prevent battery drain.
- Set the 3-position switch to REMOTE to control your Inverter at a distance with a wired remote control module (Tripp Lite Model # APSRM4; sold separately).

2 "LOAD" LEDs:

intuitive "traffic light" signals show the approximate connected equipment load level. See Operation section for instructions on reading the indicator lights.

3 "BATTERY" LEDs:

these three lights will turn ON in several sequences to show approximate battery charge level. See Operation section for instructions on reading the indicator lights.

4 DC Power Terminals:

connect to your battery terminals. See Battery Connection section for instructions.

5 Resettable Circuit Breaker:

protects your Inverter against damage due to output overload. If the breaker trips, remove some of the load on the Inverter to prevent overload, then wait at least 1 minute to allow components to cool before resetting the circuit breaker.

6 NEMA 5-15/20R AC Receptacles:

allow you to connect equipment that would normally be plugged into a utility outlet.

7 Remote Control Module Connector:

allows remote monitoring and control with an optional module (Tripp Lite Model # APSRM4; sold separately). See remote module owner's manual for connection instructions.

8 Battery Charge Conservator (Load Sense) Dial:

conserves battery power by setting the low-load level at which the Inverter automatically shuts off. See Configuration section for setting instructions.

9 Main Ground Lug:

properly grounds the Inverter to vehicle grounding system or to earth ground. See Configuration section for instructions.

10 Multi-Speed Cooling Fan:

quiet, efficient fan prolongs equipment service life.

11 Ignition Switch Control Jack (side panel, not shown):

use to connect the Inverter to your vehicle's ignition switch (with user supplied cable) in order to automatically control the Inverter with the vehicle's ignition switch. See Operation section.

12 Inverter ON/OFF Indicator Jack (side panel, not shown):

use to connect the Inverter to a user-supplied on/off indicator. See Operation section.

Operation

Switch Modes

Switch between the following operating modes as appropriate to your situation:

ON: Move the switch to the ON position to have your Inverter provide connected equipment with AC power by converting DC power from an attached battery.

OFF: Move the switch to the OFF position to shut down the Inverter completely, preventing it from drawing power from the battery. Leave the switch in the OFF position when not using connected equipment to prevent battery drain. Also use this setting to automatically reset the unit if it shuts down due to overload or overheating. First remove the excessive load or allow the unit to sufficiently cool (applicable to your situation). Switch to OFF, then back to ON. If unit fails to reset, remove additional load or allow the unit to cool further and try again.

REMOTE: Move the switch to the REMOTE position to control your Inverter at a distance with a wired remote control module (Tripp Lite Model # APSRM4; sold separately). Consult the remote control module owner's manual for more information.

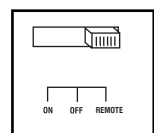
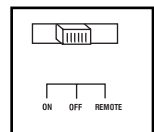
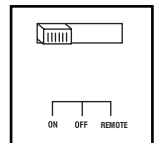

Continued on next page.

Operation (continued)

Indicator Lights

Your Inverter is equipped with a simple, intuitive, user-friendly set of indicator lights.

LOAD LOW/MED/HIGH LEDs: These three lights show the power demand on your Inverter.

LED Function with Switch in ON or REMOTE Position

LEDs Illuminated	Load Level*
1 Green	0% - 50%
2 Green & Yellow	51% - 75%
3 Yellow	76% - 100%
4 Red	101% - 125%
5 Flashing Red (2/second) Flashing Red (4/second)	Overload Overload (Inverter shutdown)**
6 All three lights off	Inverter off

* Levels listed are approximate and vary with application. ** Inverter shutdown protects inverter, batteries and equipment from possible damage due to overload conditions.

BATTERY HIGH/MED/LOW LEDs: If the operating mode switch is in the ON or REMOTE position, the LEDs indicate the approximate charge level and voltage of your connected battery bank and alert you to several fault conditions.

LED Function with Switch in ON or REMOTE Position

Approximate Battery Charge Level*

LEDs Illuminated	Battery Capacity
1 Green	91%–Full
2 Green & Yellow	81%–90%
3 Yellow	61%–80%
4 Yellow & Red	41%–60%
5 Red	21%–40%
6 Flashing Red (2/second)	1%–20%
7 Flashing Red (4/second)	0% (Inverter shutdown)**

* Levels listed are approximate. Actual conditions vary depending on battery condition and load. ** Inverter shutdown protects battery against damage due to excessive discharge.

Fault Condition

LEDs Illuminated	Fault Condition
1 All three lights flash slowly*	Excessive discharge (Inverter shutdown)

*Approximately 1/2 second on, 1/2 second off. See Troubleshooting section. Inverter shutdown protects battery against damage due to excessive discharge.

Resetting Your Inverter to Restore AC Power

Your Inverter may cease supplying AC power in order to protect itself from overload or to protect your electrical system. To restore normal functioning:

- **Low Battery Shutdown Reset:** Set switch to "OFF" and run vehicle engine to recharge battery. When battery is adequately charged, set switch back to "ON" or "REMOTE."
- **Overload Shutdown Reset:** Set switch to "OFF" and remove some of the connected electrical load (ie: turn off some of the AC devices drawing power which may have caused the overload of the unit). Wait one minute, then set switch back to "ON" or "REMOTE."
- **Output Circuit Breaker Reset:** Alternatively, check output circuit breaker on the unit's front panel. If tripped, remove some of the electrical load, then wait one minute to allow components to cool before resetting the circuit breaker. See Troubleshooting for other possible reasons AC output may be absent.

Additional Connections—Optional

Set Battery Charge Conserver (Load Sense) Dial—OPTIONAL

In order to save battery power, the Inverter automatically shuts off in the absence of any power demand from connected equipment or appliances (the electrical load). When the unit detects a load, it automatically turns on. Users may choose the minimum load the Inverter will detect by adjusting the Battery Charge Conserver Dial (see diagram). Using a small tool, turn the dial clockwise to lower the minimum load that will be detected, causing the inverter to turn on for smaller loads. When the dial is turned fully clockwise, the inverter will operate even when there is no load. Turn the dial counterclockwise to increase the minimum load that will be detected, causing the inverter to stay off until the new minimum load is reached.

Note: the factory setting for the dial is fully clockwise. However, based on the threshold load to which you'd like the inverter to respond, you should adjust the dial counterclockwise to reduce its sensitivity until the inverter is active only when connected equipment or appliances are actually in use.

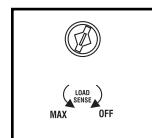

Operation (continued)

Connect Remote Control—OPTIONAL

All models feature an 8-conductor telephone style receptacle on the front panel for use with an optional remote control module (Tripp Lite model APSRM4, sold separately). The remote module allows the Inverter to be mounted in a compartment or cabinet out of sight, while operated conveniently from a vehicle's dashboard. See instructions packed with the remote control module.

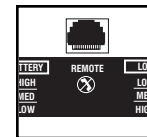

Connect Ignition Switch Control Jack—OPTIONAL

This jack (located on the Inverter's side panel) can be used to connect the Inverter to your vehicle's ignition switch in order to automatically control the Inverter. This connection is optional; the Inverter will function without this connection.



WARNING! THE IGNITION SWITCH CONTROL FUNCTION IS ONLY FOR USE WITH 12V NEGATIVE GROUND SYSTEMS. Wiring the Ignition Switch Control Cable to your vehicle's ignition requires a qualified technician, who must determine the proper wiring procedure.

When connected to the vehicle's ignition switch, this function automatically disables (turns OFF) the AC power output from the Inverter when the vehicle's ignition switch is placed in the "Engine Run" position. This function will satisfy local codes and requirements concerning video monitors (or TVs) that are located within a driver's view by automatically turning them off when the engine is started. Tripp Lite makes a current-limited cable assembly (part # 73-0977) for this purpose. Connect the current-limited cable's red wire to the ignition switch's "Engine Run" terminal. The cable's black wire can be left unterminated. Then, connect the current-limited cable's mini-plug to the Ignition Switch Control Jack located on the Inverter's side panel. After connecting the interface cable, set the Inverter's switch to "ON". The current-limited cable's mini-plug should remain in the Inverter's Ignition Switch Control Jack whenever the ignition is on to avoid shorting the battery.

Connect Inverter ON/OFF Indicator Jack—OPTIONAL

This jack can be used to connect the Inverter to a user-supplied on/off indicator. This connection is optional; the Inverter will function without this connection. Refer to the diagram for the jack's pin functions.

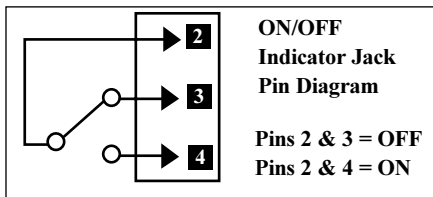

Application Guide

Match Battery Amp-Hour Capacity to Your Application

Select a battery or system of batteries that will provide your Inverter with proper DC voltage and an adequate amp-hour capacity to power your application. Even though Tripp Lite Inverters are highly-efficient at DC-to-AC inversion, their rated output capacities are limited by the total amp-hour capacity of connected batteries and the support of your vehicle's alternator if the engine is kept running.



• STEP 1: Determine Total Wattage Required

Add the wattage ratings of all equipment you will connect to your Inverter. Wattage ratings are usually listed in equipment manuals or on nameplates. If your equipment is rated in amps, multiply that number times AC utility voltage to determine watts. (Example: a ¼ in. drill requires 2½ amps. 2½ amps × 120 volts = 300 watts .)



Note: Your Inverter will operate at higher efficiencies at about 75% - 80% of nameplate rating.

Example

Tools

¼" Drill  300W	Orbital Sander  220W	Cordless Tool Charger  20W
+ + + =		
540W		

Appliances

Blender  300W	Color TV  140W	Laptop Computer  100W
+ + + =		
540W		

Continued on next page.

Application Guide (continued)

- **STEP 2: Determine DC Battery Amps Required**

Divide the total wattage required (from step 1, above) by the battery voltage (12) to determine the DC amps required.

$$540 \text{ watts} \div 12\text{V} = \mathbf{45 \text{ DC Amps}}$$

- **STEP 3: Estimate Battery Amp-Hours Required (for operation unsupported by the alternator)**

Multiply the DC amps required (from step 2, above) by the number of hours you estimate you will operate your equipment exclusively from battery power before you have to recharge your batteries. Compensate for inefficiency by multiplying this number by 1.2. This will give you a rough estimate of how many amp-hours of battery power (from one or several batteries) you should connect to your Inverter.

$$45 \text{ DC Amps} \times 5 \text{ Hrs. Runtime} \\ \times 1.2 \text{ Inefficiency Rating} = \mathbf{270 \text{ Amp-Hours}}$$

NOTE! Battery amp-hour ratings are usually given for a 20-hour discharge rate. Actual amp-hour capacities are less when batteries are discharged at faster rates. For example, batteries discharged in 55 minutes provide only 50% of their listed amp-hour ratings, while batteries discharged in 9 minutes provide as little as 30% of their amp-hour ratings.

Mounting



WARNING! Mount your Inverter BEFORE DC battery and AC power connection. Failure to follow these instructions may lead to personal injury and/or damage to the Inverter and connected systems.

Tripp Lite manufactures a variety of different Inverters with a variety of different mounting options for use in vehicular or non-vehicular applications. Tripp Lite recommends permanent mounting of your Inverter. User must supply mounting hardware and is responsible for determining if the hardware and mounting surface are suitable to support the weight of the Inverter. Contact Tripp Lite if you require further assistance in mounting your Inverter.

- A** Using the measurements from the diagram, install two user-supplied 1/4" (6 mm) fasteners into a rigid horizontal surface, leaving the heads slightly raised.
- B** Slide the Inverter forward over the fasteners to engage the mounting feet molded on the front of the Inverter cabinet. Install and tighten additional user-supplied 1/4" (6 mm) fasteners into the mounting feet molded on the rear of the Inverter cabinet. The rear feet extend beyond the unit's cabinet to provide for adequate ventilation space behind the cooling fan(s); they should not be removed.

The polycarbonate cabinet and mounting feet of your Inverter are durable enough to allow for vertical mounting as well, if your vehicle compartment requires this configuration. For vertical mounting, the control panel of the Inverter should face up.

Allow 2" (5 cm.) minimum front and rear clearance for adequate ventilation.

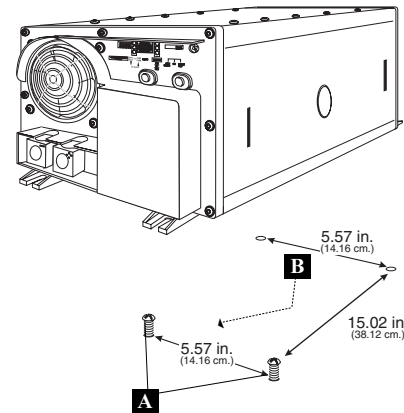

Battery Connection and Cable Sizing Chart

Connect your Inverter to your batteries using the following procedures:

- **Connect DC Wiring:** Though your Inverter is a high-efficiency converter of electricity, its rated output capacity is limited by the length and gauge of the cabling running from the battery to the unit. Use the shortest length and largest diameter cabling (maximum 2/0 gauge) to fit your Inverter's DC Input terminals. Shorter and heavier gauge cabling reduces DC voltage drop and allows for maximum transfer of current. Your Inverter is capable of delivering peak wattage at up to 200% of its rated continuous wattage output for brief periods of time. Heavier gauge cabling should be used when continuously operating heavy draw equipment under these conditions. Tighten your Inverter and battery terminals to approximately 3.5 Newton-meters of torque to create an efficient connection and to prevent excessive heating at this connection. Insufficient tightening of the terminals could void your warranty.

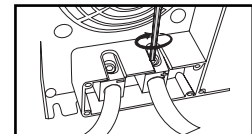

DC Connectors

Battery Connection and Cable Sizing Chart (continued)

- **Connect Ground:** Using a #8 AWG wire or larger directly connect the Main Ground Lug to the vehicle's chassis or earth ground. See the Feature Identification section to locate the Main Ground Lug on your specific Inverter model. All installations must comply with national and local codes and ordinances.
- **Connect Fuse:** NEC (National Electrical Code) article 551 requires that you connect all of your Inverter positive DC Terminals directly to a UL-listed fuse(s) and fuse block(s) within 18 inches of the battery. The fuse's rating must equal or exceed the Minimum DC Fuse Rating listed in your Inverter's specifications. See diagrams below for proper fuse placement.



WARNING! • Failure to properly ground your Inverter to a vehicle's chassis or earth ground may result in a lethal electrical shock hazard. • Never attempt to operate your Inverter by connecting it directly to output from an alternator rather than a battery or battery bank. • Observe proper polarity with all DC connections.

Minimum Recommended Cable Sizing Chart[†]

Always loosely twist each pair of cables together before connecting them separately to the appropriate DC terminal on the Inverter (positive or negative).

Watts	Wire Gauge				
	2 Conductors				
	6	4	2	0	00
500	15 ft	25 ft	39 ft	62 ft	79 ft
700	11 ft	18 ft	28 ft	44 ft	56 ft
1000	N/R	12 ft	20 ft	31 ft	39 ft
2000	N/R	N/R	N/R	16 ft	20 ft

[†] N/R = Not Recommended. NOTE: Acceptable power is directly related to cable length (i.e. - the shorter the cable, the better the performance)

Vehicular

Your Inverter's Nominal DC Input Voltage **must match** the voltage of your battery or batteries—12 Volts in most vehicular applications.

It is possible to connect your Inverter to the main battery within your vehicle's electrical system. In most vehicles, the Inverter will be connected to one or more dedicated auxiliary (house) batteries which are isolated from the drive system to prevent possible draining of the main battery.

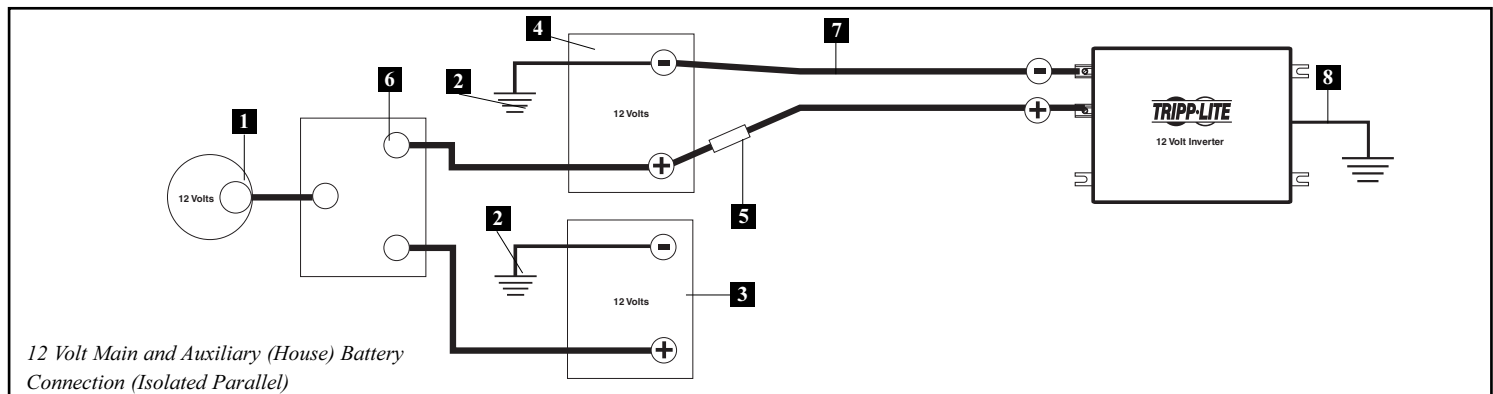
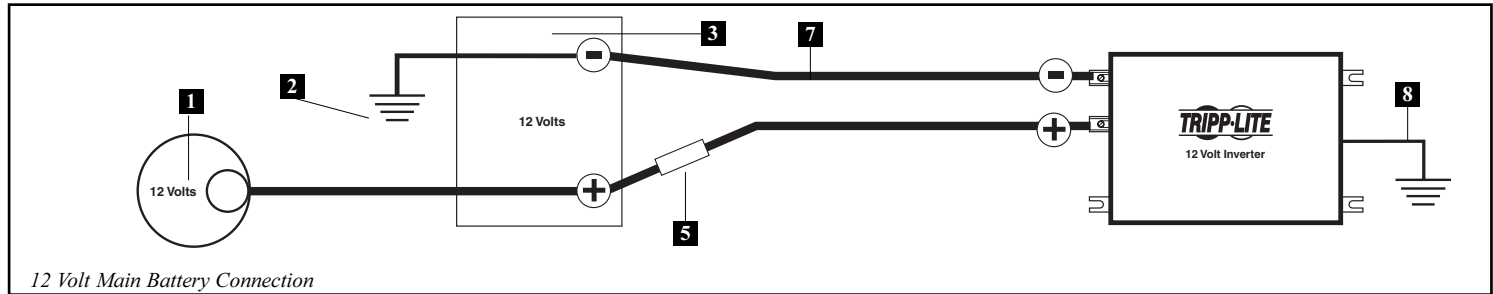

- 1 12 Volt Alternator 2 Vehicle Battery Ground 3 12 Volt Main Battery 4 12 Volt Auxiliary (House) Battery 5 UL-Listed Fuse & Fuse Block (mounted within 18 inches of the battery) 6 Battery Isolator 7 Large Diameter Cabling, Maximum 00 Gauge to Fit Terminals 8 8 AWG (minimum) Ground Wire

AC Output Connection

To avoid overloading your Inverter, be sure to match the power requirements of the equipment you plan to run at any one time (add their total watts) with the output wattage capacity of your Inverter model. When figuring the power requirements of your equipment, do not confuse "continuous" wattage with "peak" wattage ratings. Most electric motors require extra power at start-up ("peak" wattage) than required to run continuously after start-up, sometimes over 100% more. Some motors, such as in refrigerators and pumps, start and stop intermittently according to demand, requiring "peak" wattage at multiple, unpredictable times during operation.

- **DoubleBoost™ Feature:** Tripp Lite Inverters deliver up to twice their nameplate rated wattage for up to 10 seconds,* providing the extra power needed to cold start heavy-duty tools and equipment.
- **OverPower™ Feature:** Tripp Lite Inverters deliver up to 150% of their name plate rated wattage for up to 1 hour,* providing plenty of reserve power to reliably support tools and equipment longer.

* Actual duration depends on battery age, battery charge level and ambient temperature.

Service

Before returning your Inverter for service, follow these steps: 1.) Review the installation and operation instructions to ensure that the service problem does not originate from a misreading of the instructions. Also, check that the circuit breaker(s) are not tripped.* 2.) If the problem continues, do not contact or return the Inverter to the dealer. Instead, call Tripp Lite at (773) 869-1233. A service technician will ask for the Inverter's model number, serial number and purchase date and will attempt to correct the problem over the phone. 3.) If the problem requires service, the technician will issue you a Returned Material Authorization (RMA) number, which is required for service. Securely pack the Inverter to avoid damage during shipping. If possible, use the original packing material that came with the unit. Do not use Styrofoam beads for packaging.** Any damages (direct, indirect, special, incidental or consequential) to the Inverter incurred during shipment to Tripp Lite or an authorized Tripp Lite service center is not covered under warranty. Inverters shipped to Tripp Lite or an authorized Tripp Lite service center must have transportation charges prepaid. Mark the RMA number on the outside of the package. If the Inverter is within the warranty period, enclose a copy of your sales receipt. Return the Inverter for service using an insured carrier to the address given to you by the Tripp Lite service technician.

** This is a common cause of service inquiries which can be easily remedied by following the resetting instructions in this manual. ** If you require packaging, the technician can arrange to send you proper packaging.*

Maintenance

Your Inverter requires no maintenance and contains no user-serviceable or replaceable parts, but should be kept dry at all times. Periodically check, clean and tighten all cable connections, as necessary, both at the unit and at the battery.

Troubleshooting

Try these remedies for common Inverter problems before calling for assistance. Call Tripp Lite Customer Service at (773) 869-1234 before returning your unit for service.

SYMPTOM	PROBLEMS	CORRECTIONS
No AC Output (All Indicator Lights Are OFF)	Operating Mode Switch is set to "OFF."	Set Operating Mode Switch to "ON" or "REMOTE."
	User-supplied UL-listed external DC input fuses have blown.	Replace fuses.
Red Battery Indicator Light Is Rapidly Flashing (¼ Second Flashes)	Unit has shut down due to excessive battery discharge.	Run your engine to raise battery voltage. Check external battery connections and fuse. Reset by moving Operating Mode Switch to "OFF." Wait one minute and switch to "ON" or "REMOTE." If unit remains in shutdown mode after several attempts to reset contact Tripp Lite Customer Service for assistance.
Red Load Indicator Light Is Rapidly Flashing (¼ Second Flashes)	Unit has shut down due to overload.	Reduce load. Reset by moving Operating Mode Switch to "OFF." Wait one minute and switch to "ON" or "REMOTE." If unit remains in shutdown mode after several attempts to reset contact Tripp Lite Customer Service for assistance.
Connected Equipment Experiences Buzzing Sound Or Picture Distortion	Audio/Video interference.	Reposition equipment antennas and Inverter.
Inverter Output Seems Intermittent	Loose cable connections.	Check and secure all connections.

Limited Warranty

Tripp Lite warrants its products to be free from defects in materials and workmanship for a period of one year (domestic) or 120 days (export) from the date of initial purchase. Tripp Lite's obligation under this warranty is limited to repairing or replacing (at its sole option) any such defective products. To obtain service under this warranty you must obtain a Returned Material Authorization (RMA) number from Tripp Lite or an authorized Tripp Lite service center. Products must be returned to Tripp Lite or an authorized Tripp Lite service center with transportation charges prepaid and must be accompanied by a brief description of the problem encountered and proof of date and place of purchase. This warranty does not apply to equipment which has been damaged by accident, negligence or misapplication or has been altered or modified in any way. This warranty applies only to the original purchaser who must have properly registered the product within 10 days of purchase.

EXCEPT AS PROVIDED HEREIN, TRIPP LITE MAKES NO WARRANTIES, EXPRESS OR IMPLIED, INCLUDING WARRANTIES OF MERCHANTABILITY AND FITNESS FOR A PARTICULAR PURPOSE. Some states do not permit limitation or exclusion of implied warranties; therefore, the aforesaid limitation(s) or exclusion(s) may not apply to the purchaser. EXCEPT AS PROVIDED ABOVE, IN NO EVENT WILL TRIPP LITE BE LIABLE FOR DIRECT, INDIRECT, SPECIAL, INCIDENTAL OR CONSEQUENTIAL DAMAGES ARISING OUT OF THE USE OF THIS PRODUCT, EVEN IF ADVISED OF THE POSSIBILITY OF SUCH DAMAGE. Specifically, Tripp Lite is not liable for any costs, such as lost profits or revenue, loss of equipment, loss of use of equipment, loss of software, loss of data, costs of substitutes, claims by third parties, or otherwise.

Tripp Lite has a policy of continuous improvement. Specifications are subject to change without notice.

Regulatory Compliance Identification Numbers

For the purpose of regulatory compliance certifications and identification, your Tripp Lite product has been assigned a unique series number. The series number can be found on the product nameplate label, along with all required approval markings and information. When requesting compliance information for this product, always refer to the series number. The series number should not be confused with the marking name or model number of the product.

Tripp Lite follows a policy of continuous improvement. Product specifications are subject to change without notice.

Warranty Registration

Visit www.tripplite.com/warranty to register the warranty of your new Tripp Lite product.

You'll be automatically entered into a drawing for a chance to win a FREE Tripp Lite product!*

** No purchase necessary. Void where prohibited. Some restrictions apply. See website for details.*



1111 W. 35th Street, Chicago, IL 60609 USA
Customer Support: (773) 869-1234
www.tripplite.com