

**3M**

# SC, FC and ST\* Hot Melt Fiber Optic Connectors

## Instructions



## Contents

1.0 Safety and Helpful Hints .....	4
2.0 Field Termination Kit Contents .....	4
3.0 ST—Installation on 900 $\mu\text{m}$ Buffered Fiber .....	6
4.0 ST—Installation on Jacketed Cable.....	8
5.0 SC—Installation on 900 $\mu\text{m}$ Buffered Fiber .....	10
6.0 SC—Installation on Jacketed Cable .....	12
7.0 FC—Installation on 900 $\mu\text{m}$ Buffered Fiber .....	14
8.0 FC—Installation on Jacketed Cable .....	16
9.0 Scribing .....	18
10.0 Multimode Polishing Procedure .....	19
11.0 Single-Mode Polishing Procedure .....	21
12.0 Field Termination Kit Replacement Part Numbers .....	24

## 1.0 Safety and Helpful Hints

Use reagent grade isopropyl alcohol that is 99% pure to clean the fibers and other components. When terminating connectors on any cable containing grease, ensure that all grease is wiped away and the buffer, coating, and fiber are thoroughly cleaned with isopropyl alcohol.

Isopropyl alcohol is not shipped with the 3M Field Termination Kits; however, a bottle for the alcohol is included.

**Note:** *Carefully follow safety, health and environmental information given on the container label or the Material Safety Data Sheet for the isopropyl alcohol being used.*

Safety glasses should be worn when working with optical fibers.

**Caution:** *Do not touch any part of the heating block of the Hot Melt Oven during operation. It is very HOT.*

**Warning:** *Do not view fiber ends if they are illuminated with a laser.*

## 2.0 Field Termination Kit Contents



2.1 Oven



2.2 Cooling Stand



2.3 ST\* Connector Holder



2.4 FC Connector Holder



2.5 SC Connector Holder

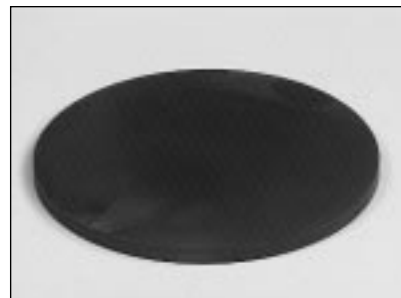

2.6 Polishing Pad



2.7 2  $\mu$ m Lapping Film (pale aqua)

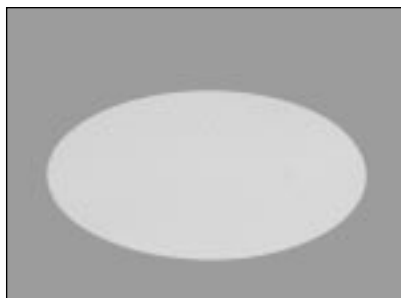

2.8 Final Lapping Film (pale yellow)



2.9 8892 Polishing Jig



2.10 6955-C Crimp Tool



2.11 Jacket Removal Tool



2.12 Scissors



2.13 6955-S Fiber Buffer and Coating Stripper



2.14 Scribe



2.15 View Scope



2.16 Lint-Free Cloths



2.17 Alcohol and Water Bottles  
(Shipped Empty)

### 3.0 ST—Installation on 900 $\mu\text{m}$ Buffered Fiber

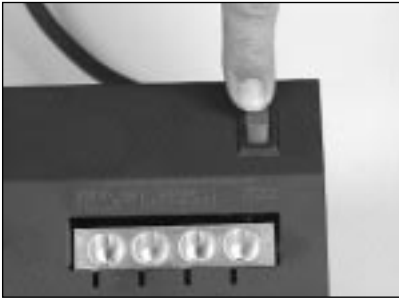

3.1 Turn on the Hot Melt Oven.  
The oven requires 5 minutes to warm up.



3.2 Open the connector package and remove the components.

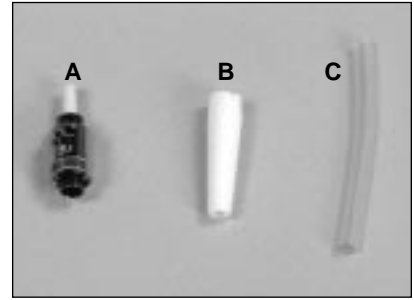

3.3 Each connector package contains a connector (A), strain relief boot (B) and clear strain relief tube (C).



3.4 Load the connector onto the ST\* connector holder.



3.5 Latch the connector bayonet housing to the connector holder.

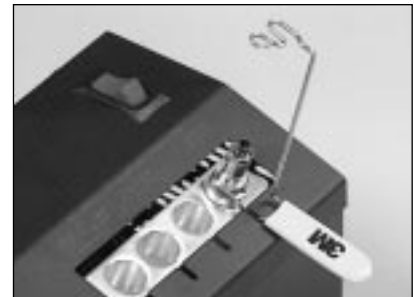

3.6 Place the connector holder and connector into the oven.

**Note:** *The connector should be in the oven for at least one minute, but no more than ten minutes.*

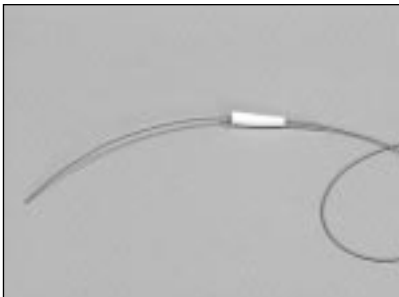

3.7 Place the strain relief boot and clear strain relief tube on the buffered fiber.



3.8 Remove the buffer in small pieces until  $\frac{5}{8}$ "– $\frac{3}{4}$ " (16–19 mm) of the buffer has been stripped.

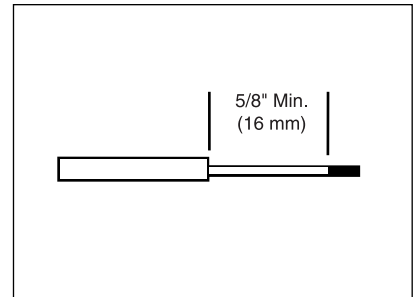

3.9 Stripping template.

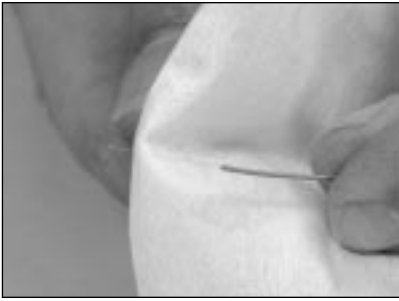

3.10 Clean the fiber with a lint free cloth moistened with isopropyl alcohol.



3.11 Remove the connector holder from the oven.

**CAUTION: VERY HOT.**



3.12 Gently insert the fiber into the connector.



3.13 Push the buffered fiber until it stops.

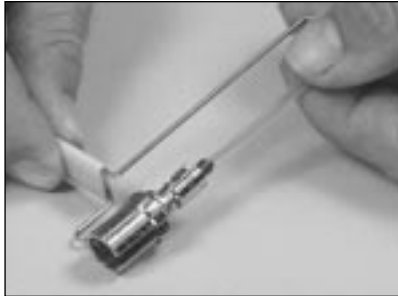

3.14 Slide the clear strain relief tube into the backbone of the connector until it stops.



3.15 Bare fiber should be visible in the bottom of the connector holder.



3.16 Place the buffered fiber in the cable holder.

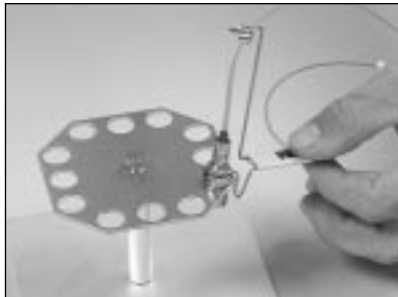

3.17 Place the connector holder into the cooling stand. The cooling time is about 3 minutes.

Proceed to Section 9: Scribing, Page 18.

## 4.0 ST—Installation on Jacketed Cable

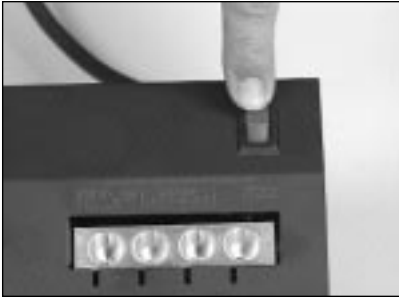

4.1 Turn on the Hot Melt Oven.  
The oven requires 5 minutes to warm up.



4.2 Open the connector package and remove the components.

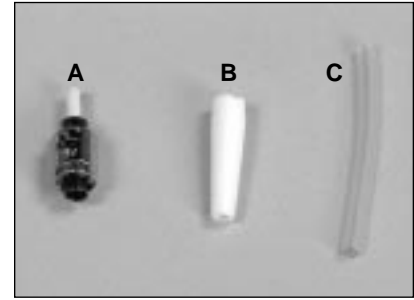

4.3 Each connector package contains a connector (A), strain relief boot (B) and clear strain relief tube (C). *The strain relief tube is not used on jacketed cable.*



4.4 Load the connector onto the ST\* connector holder.



4.5 Latch the connector bayonet housing to the connector holder.

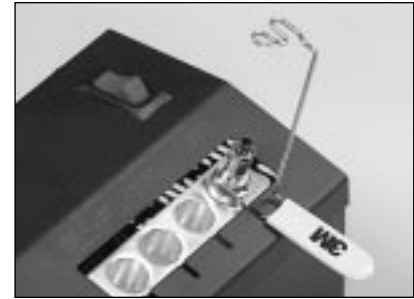

4.6 Place the connector holder and connector into the oven.

**Note:** *The connector should be in the oven for a least one minute, but no more than ten minutes.*



4.7 Place the strain relief boot on the cable.



4.8 Score the jacket  $\frac{3}{4}$ " (19 mm) to  $\frac{7}{8}$ " (22 mm) from the end.



4.9 Remove the jacket from the end of the cable.

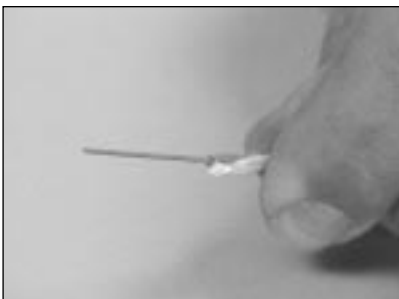

4.10 Gather the aramid yarn together and hold them against the cable jacket.

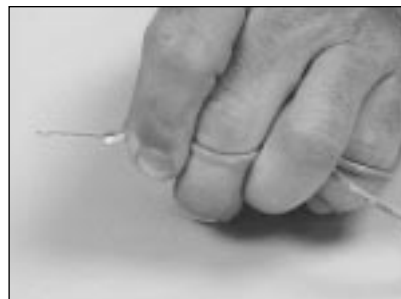

4.11 To prevent the buffered fiber from being pulled out, lace the cable through your fingers.



4.12 Remove  $\frac{5}{8}$ " (16 mm) of the buffer.



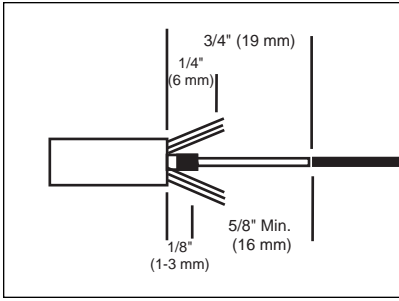

4.13 Stripping template.

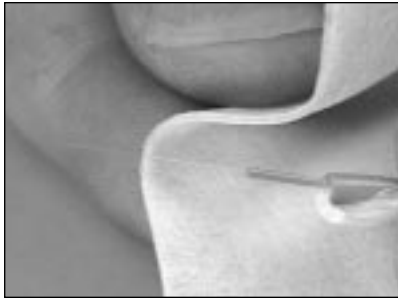

4.14 Clean the fiber with a lint free cloth moistened with isopropyl alcohol.



4.15 Cut the aramid yarn to 1/4" (6 mm) long.



4.16 Remove the connector holder from the oven.

**CAUTION: VERY HOT.**



4.17 Gently insert the fiber into the connector.



4.18 Push the cable until the aramid yarn is inside the connector.



4.19 Bare fiber should be visible in the bottom of the connector holder.



4.20 Secure the cable to the cable holder.



4.21 Place the connector holder into the cooling stand. The cooling time is about 3 minutes.

Proceed to Section 9: Scribing,  
Page 18.

## 5.0 SC—Installation on 900 $\mu$ m Buffered Fiber

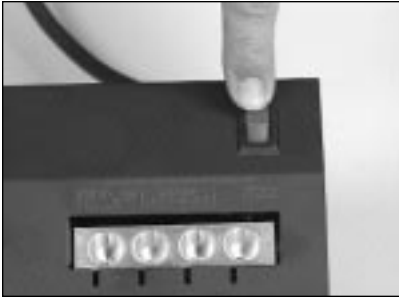

5.1 Turn on the Hot Melt oven. The oven requires 5 minutes to warm up.



5.2 Open the package and remove the components.

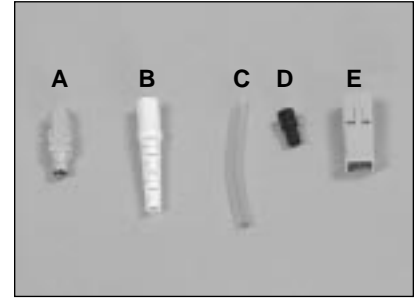

5.3 Each package contains a connector (A), strain relief boot (B), clear strain relief tube (C), black crimp ring for 3 mm cable (D) and connector shell (E).



5.4 Load the connector into the SC connector holder.



5.5 Push down on the connector and turn it 90 degrees so that the arms hold the connector in place.

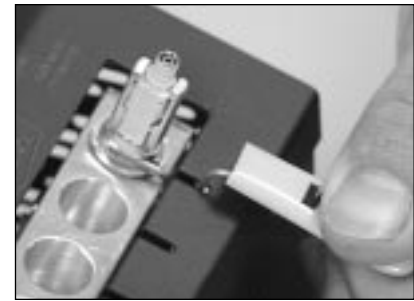

5.6 Place the connector holder and connector into the oven.

**Note:** *The connector should be in the oven for at least one minute, but no more than ten minutes.*



5.7 Place the strain relief boot, clear strain relief tubing and crimp ring on the fiber.



5.8 Remove the buffer in small pieces until  $\frac{1}{16}$ "– $\frac{5}{8}$ " (14-16 mm) of buffer has been stripped.

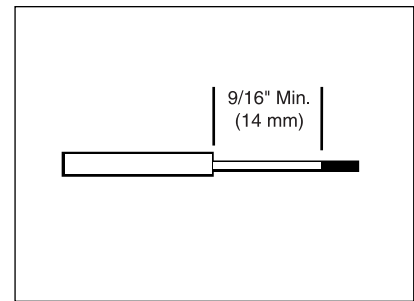

5.9 Stripping template.



5.10 Clean the fiber with a lint free cloth moistened with isopropyl alcohol.



5.11 Remove the connector holder from the oven.

**CAUTION: VERY HOT.**



5.12 Gently insert the fiber into the connector.



5.13 Push the buffered fiber until it stops.



5.14 Slide the crimp ring over the backbone until it is against the connector.



5.15 Slide the clear strain relief tube into the crimp ring.

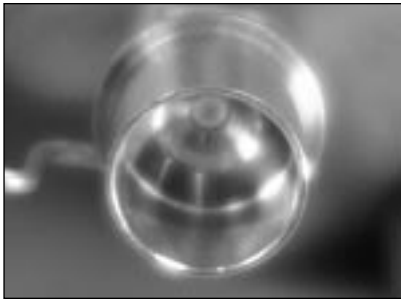

5.16 Verify that the bare fiber is visible in the bottom of the connector holder.



5.17 Crimp the larger part of the crimp ring with the .190 cavity of the crimp tool.



5.18 Crimp the smaller part of the crimp ring using the .137 cavity.

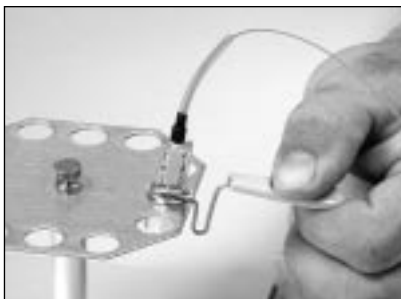

5.19 Place the connector holder into the cooling stand. The cooling time is about 3 minutes.

Proceed to Section 9: Scribing,  
Page 18.

## 6.0 SC—Installation on Jacketed Cable



6.1 Turn on the Hot Melt oven. The oven requires 5 minutes to warm up.



6.2 Open the package and remove the components.

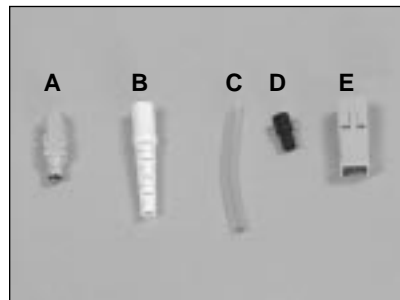

6.3 Each package contains a connector (A), strain relief boot (B), clear strain relief tube (C), black crimp ring for 3 mm cable (D) and connector shell (E). *The strain relief tube is not used on jacketed cable.*



6.4 Load the connector into the SC connector holder.



6.5 Push down on the connector and turn it 90 degrees so that the arms hold the connector in place.



6.6 Place the connector holder and connector into the oven.

**Note:** *The connector should be in the oven for at least one minute, but no more than ten minutes.*



6.7 Place the strain relief boot and crimp ring on the cable.



6.8 Score the jacket 1 3/16" (30 mm) from the end.



6.9 Remove the jacket from the end of the cable.

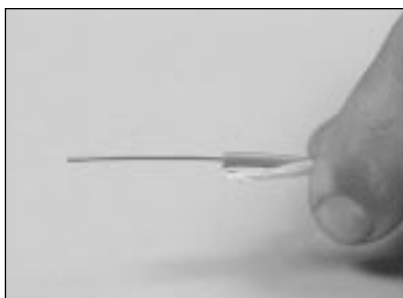

6.10 Gather the aramid yarn together and hold them against the cable jacket.

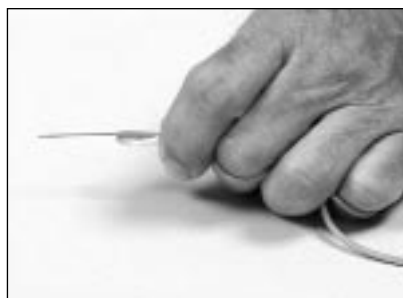

6.11 To prevent the buffered fiber from being pulled out, lace the cable through your fingers.



6.12 Remove the buffer in small pieces until 1/16"–5/8" (14-16 mm) of the buffer remains.

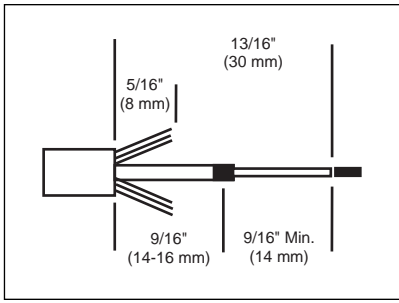

6.13 Stripping template.



6.14 Clean the fiber with a lint free cloth moistened with isopropyl alcohol.



6.15 Cut the aramid yarn to  $\frac{5}{16}$ " (8 mm) long.



6.16 Remove the connector holder from the oven.

**CAUTION: VERY HOT.**



6.17 Gently insert the fiber into the connector.



6.18 Push the cable until it stops against the connector. The aramid yarn should flare out over the backbone.



6.19 Slide the crimp ring over the aramid yarn until it is seated against the connector.



6.20 Verify that the bare fiber is visible in the bottom of the connector holder.



6.21 Crimp the larger part of the crimp ring with the .190 cavity of the crimp tool.



6.22 Crimp the smaller part of the crimp ring using the .137 cavity. (Use the .120 cavity for the optional 2.4 mm crimp ring.)



6.23 Place the connector holder into the cooling stand. The cooling time is about 3 minutes.

## 7.0 FC—Installation on 900 $\mu$ m Buffered Fiber

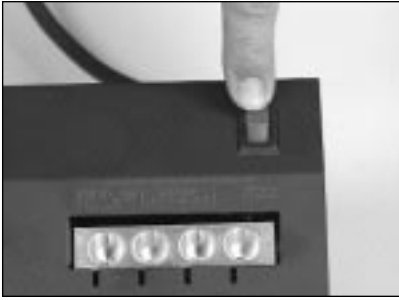

7.1 Turn on the Hot Melt oven. The oven requires 5 minutes to warm up.



7.2 Open the package and remove the components.

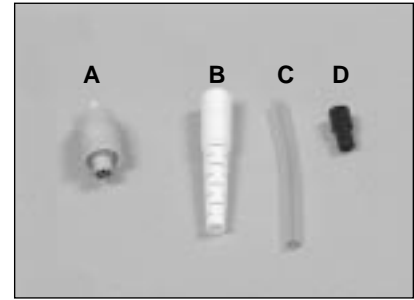

7.3 Each package contains a connector (A), strain relief boot (B), clear strain relief tube (C) and black crimp ring for 3 mm cable (D).



7.4 Load the connector into the FC connector holder. Align the key on the connector with the key way on the connector holder.



7.5 Place the connector holder and connector into the oven.

**Note:** *The connector should be in the oven for at least one minute, but no more than ten minutes.*

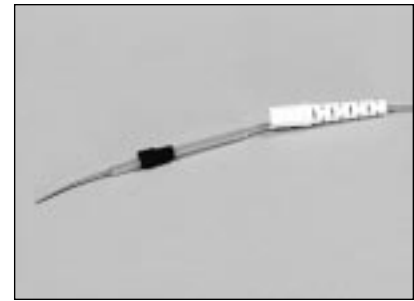

7.6 Place the strain relief boot, clear strain relief tube and crimp ring on the fiber.



7.7 Remove the buffer in small pieces until  $\frac{9}{16}$ "– $\frac{5}{8}$ " (14-16 mm) of buffer has been stripped.

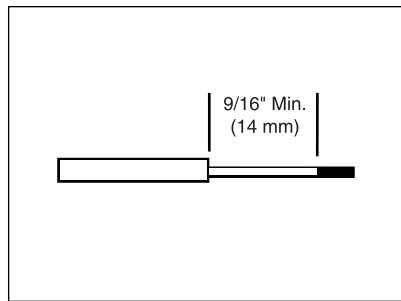

7.8 Stripping template.



7.9 Clean the fiber with a lint free cloth moistened with isopropyl alcohol.



7.10 Remove the connector holder from the oven.

**CAUTION: VERY HOT.**



7.11 Gently insert the fiber into the connector.



7.12 Push the fiber until it stops.



7.13 Slide the crimp ring over the backbone until it is against the connector.



7.14 Slide the clear strain relief tube into the crimp ring.

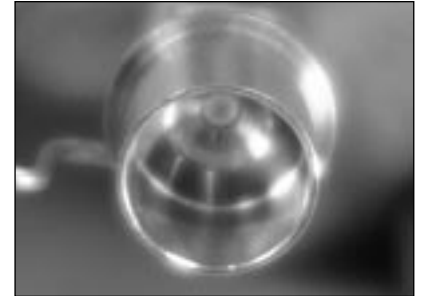

7.15 Verify that the bare fiber is visible in the bottom of the connector holder.



7.16 Crimp the larger part of the crimp ring with the .190 cavity of the crimp tool.



7.17 Crimp the smaller part of the crimp ring using the .137 cavity.



7.18 Place the connector holder into the cooling stand. The cooling time is about 3 minutes.

Proceed to Section 9: Scribing,  
Page 18.

## 8.0 FC—Installation on Jacketed Cable

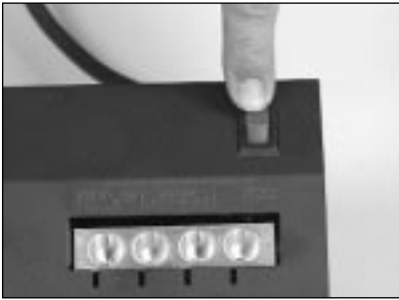

8.1 Turn on the Hot Melt oven. The oven requires 5 minutes to warm up.



8.2 Open the package and remove the components.

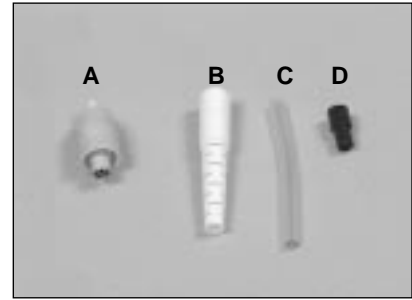

8.3 Each package contains a connector (A), strain relief boot (B), clear strain relief tube (C) and black crimp ring for 3 mm cable (D). *The strain relief tube is not used on jacketed cable.*



8.4 Load the connector into the FC connector holder. Align the key on the connector with the key way on the connector holder.



8.5 Place the connector holder and connector into the oven.

**Note:** *The connector should be in the oven for at least one minute, but no more than ten minutes.*



8.6 Place the strain relief boot and crimp ring on the cable.



8.7 Score the jacket  $1\frac{3}{16}$ " (30 mm) from the end.



8.8 Remove the jacket from the end of the cable.

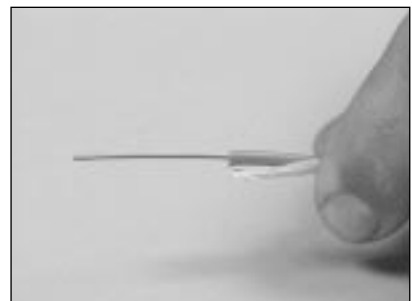

8.9 Gather the aramid yarn together and hold them against the cable jacket.



8.10 To prevent the buffered fiber from being pulled out, lace the cable through your fingers.



8.11 Remove the buffer in small pieces until  $\frac{9}{16}$ " (14 mm) of the buffer remains.

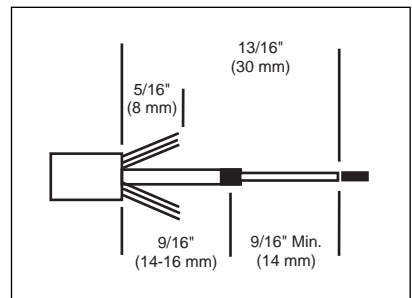

8.12 Stripping template.





8.13 Clean the fiber with a lint free cloth moistened with isopropyl alcohol.



8.14 Cut the aramid yarn to  $\frac{5}{16}$ " (8 mm) long.



8.15 Remove the connector holder from the oven.

**CAUTION: VERY HOT.**



8.16 Gently insert the fiber into the connector.



8.17 Push the cable until it stops against the connector. The aramid yarn should flare out over the backbone.



8.18 Slide the crimp ring over the aramid yarn until it is seated against the connector.

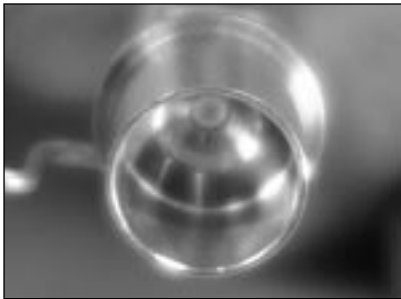

8.19 Verify that the bare fiber is visible in the bottom of the connector holder.



8.20 Crimp the larger part of the crimp ring with the .190 cavity of the crimp tool.



8.21 Crimp the smaller part of the crimp ring using the .137 cavity. (Use the .120 cavity for the optional 2.4 mm crimp ring)



8.22 Place the connector holder into the cooling stand. The cooling time is about 3 minutes.

## 9.0 Scribing



9.1 Remove the connector from the connector holder.



**Caution:** *Be careful so that you do not break the protruding fiber.*



9.2 Score the fiber by gently sliding the blades across the fiber just above the adhesive bead. Scoring means that you are making a small scratch on the outside of the fiber. Be very gentle.



9.3 Pull the fiber away from the connector. Pull along the axis of the fiber, not to one side or the other. If the fiber does not break away, score the fiber again.



**Caution:** *Dispose of the fiber per company practice.*

## 10.0 Multimode Polishing Procedure

This procedure is for multimode connectors and single-mode connectors that require only a -27 dB reflection. For single-mode applications that require better reflection performance, follow the procedure in Section 11.

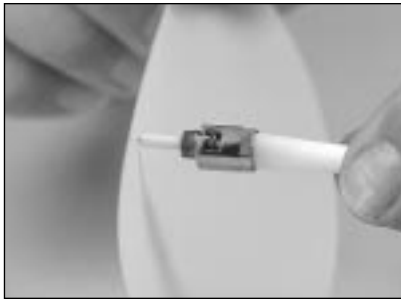

10.1 Perform an air polish on the fiber by gently moving the connector in a circular motion on the 2 micron lapping film (pale aqua color).



10.2 Clean the polishing jig with a lint free cloth moistened with isopropyl alcohol.



10.3 Clean the rubber pad with a lint free cloth moistened with isopropyl alcohol.



10.4 Wipe a layer of alcohol onto the rubber pad.



10.5 Before the alcohol evaporates, place the 2 micron lapping film on the rubber pad shiny side down. The alcohol creates a suction on the lapping film and helps hold it in place.



10.6 Clean the lapping film with a lint free cloth moistened with isopropyl alcohol.

**Note: The 2 micron polishing film may be used for two connectors.**



10.7 Place the connector ferrule in the polishing jig to verify that it fits properly. The fit should allow for easy movement of the ferrule.



10.8 If the ferrule does not fit properly, there are two possible causes. The first is that there is adhesive on the ferrule. To remove the adhesive, use the scissors and gently scrape away the adhesive.



10.9 The second possibility is that the hole in the jig may have adhesive in it. Saturate a pipe cleaner with isopropyl alcohol and move it back and forth in the jig to remove the adhesive.



10.10 Place the jig on the lapping film.

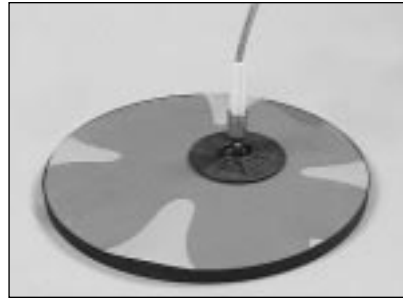

10.11 Place the ferrule in the jig until it stops.



10.12 Hold the connector as shown.



10.13 Beginning with a light pressure, move the jig in a figure eight pattern. The speed of your figure eights should be between one and two per second.

After you have done 5 figure eights, increase to a medium pressure and polish until all of the adhesive has been removed. Then, polish an additional 3 figure eights.

**Note:** *The jig will feel much easier to push immediately after the adhesive has been removed.*



10.14 Clean the connector end face with a lint free cloth moistened with isopropyl alcohol.



10.15 Inspect the connector end face with the view scope.



10.16 Turn on the light and adjust the focus.

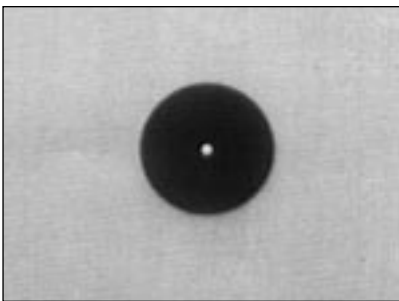

10.17 Good polish (single-mode)

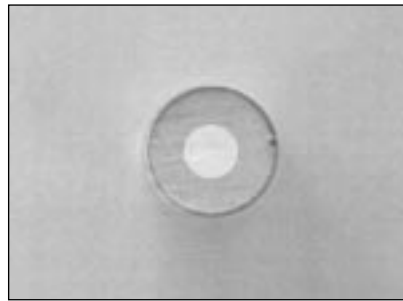

10.18 Good polish (multimode)

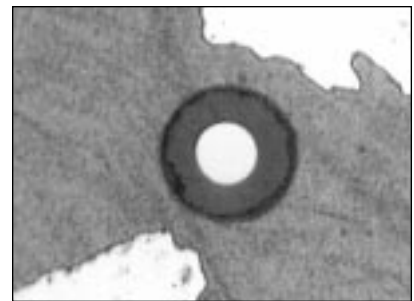

10.19 Needs more polishing.

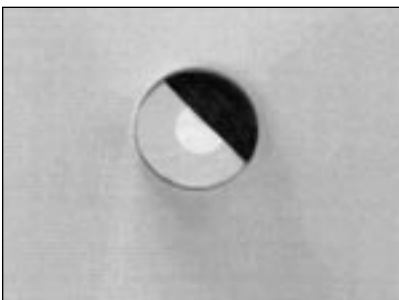

10.20 Too much pressure when scribing.

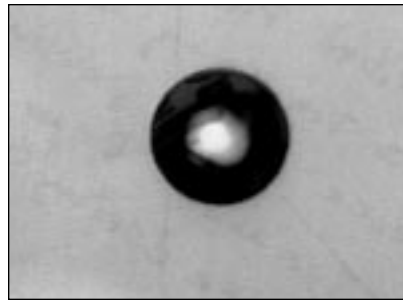

10.21 Scribed fiber was too long and broke during polishing or too much downward pressure during polishing.



10.22 ST Connector—Install the boot on the connector.



10.23 FC Connector—Install the boot on the connector.



10.24 SC connector—Align the flats of the boot with the flat sides of the connector body.

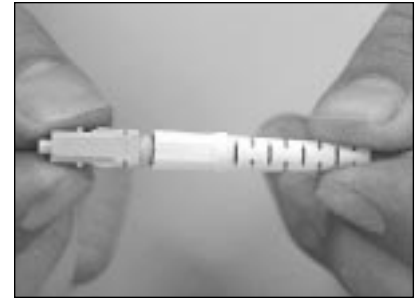

10.25 Push the boot into place.



10.26 Install the shell by aligning the chamfers in the shell with the chamfers on the connector.

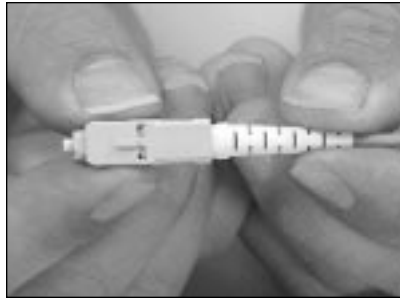

10.27 Push firmly on the shell until it snaps in place.



10.28 Install the dust cap on the connector.

## 11.0 Single-Mode Polishing Procedure



11.1 Perform an air polish on the fiber by gently moving the connector in a circular motion on the 2 micron lapping film (pale aqua color).



11.2 Clean the polishing jig with a lint free cloth moistened with isopropyl alcohol.



11.3 Clean the rubber pad with a lint free cloth moistened with isopropyl alcohol.



11.4 Wipe a layer of alcohol onto the rubber pad.

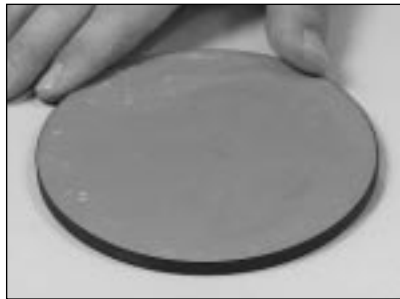

11.5 Before the alcohol evaporates, place the 2 micron lapping film on the rubber pad shiny side down. The alcohol creates a suction on the lapping film and helps hold it in place.



11.6 Clean the lapping film with a lint free cloth moistened with isopropyl alcohol.

**Note:** *The 2 micron lapping film should be used for one connector only.*



11.7 Place the connector ferrule in the polishing jig to verify that it fits properly. The fit should allow for easy movement of the ferrule.



11.8 If the ferrule does not fit properly, there are two possible causes. The first is that there is adhesive on the ferrule. To remove the adhesive, use the scissors and gently scrape away the adhesive.



11.9 The second possibility is that the hole in the jig may have adhesive in it. Saturate a pipe cleaner with isopropyl alcohol and move it back and forth in the jig to remove the adhesive.



11.10 Place the jig on the lapping film.

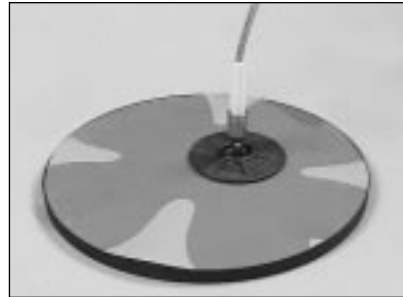

11.11 Place the ferrule in the jig until it stops.



11.12 Hold the connector as shown.



11.13 Beginning with a light pressure, move the jig in a figure eight pattern.

11.14 The speed of your figure eights should be between one and two per second.

After you have done 5 figure eights, increase to a medium pressure and polish until all of the adhesive has been removed. Then, polish one additional figure eight only.

**Note: The jig will feel much easier to push immediately after the adhesive has been removed.**



11.15 Clean the second rubber pad.



11.16 Wipe a layer of alcohol onto the rubber pad.

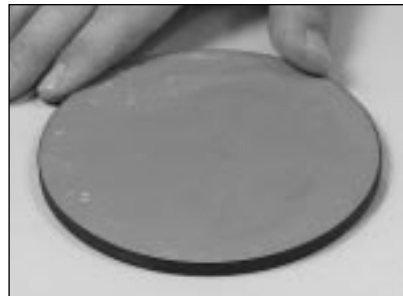

11.17 Before the alcohol evaporates, place the 0.05 Micron Lapping film (pale yellow) on the rubber pad shiny side down.



11.18 Clean the lapping film with a lint free cloth moistened with isopropyl alcohol.

**Note: The SM Final Polish film may be used for up to 8 connectors.**



11.19 Add several drops of distilled water to the lapping film.



11.20 Place the jig on the lapping film.

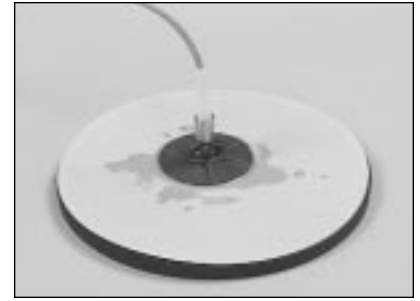

11.21 Place the ferrule in the jig until it stops.



11.22 Hold the connector as shown.



11.23 Polish the connector for 3 **figure eights only.**



11.24 Clean the connector end face with a lint free cloth moistened with isopropyl alcohol.



11.25 Inspect the connector end face with the view scope. Section 10 has pictures of properly and improperly polished connectors.



11.26 Install the dust cap on the connector.

## 12.0 Field Termination Kit Replacement Part Numbers

Field Termination Kit Replacement Part Numbers				Bulk Packaged Connectors, Buffer boot, and 2.4 mm Crimp Ring			
Part Number	Description	Qty	Packaging	Part Number	Description	Qty	Packaging
80-6110-0936-8	6355-V Hot Melt Oven, 110V	1	each	80-6108-6138-9	6300 SC Hot Melt MM, white boot	60	package
80-6110-1284-2	6351-V Hot Melt Oven, 230V	1	each	80-6109-3552-2	6300-R SC Hot Melt MM, red boot	60	package
80-6106-2569-3	Cooling Stand, Hot Melt	1	each	80-6109-3555-5	6300-B SC Hot Melt MM, black boot	60	package
80-6110-0926-9	ST Connector Holders	4	package	80-6108-6136-3	6100 ST Hot Melt MM, white boot	60	package
80-6108-4630-7	SC Connector Holders	4	package	80-6109-3553-0	6100-R ST Hot Melt MM, red boot	60	package
80-6108-4614-1	FC Connector Holders	4	package	80-6109-3554-8	6100 ST Hot Melt MM, black boot	60	package
80-6110-0933-5	Polishing Pad One Step	1	each	80-6110-0929-3	Buffer Boot for SC and FC, white	60	package
60-6500-2346-2	Lapping Film 2 µm A/O	50	package	80-6110-0930-1	Crimp Ring, 2.4 mm, red	60	package
60-6500-2575-6	Lapping Film 0.05 µm A/O	50	package				
80-6110-0932-7	8892 Polishing Jig	1	each				
80-6109-3725-4	Crimp Tool 6955-C	1	each				
80-6104-4314-7	Stripper, Cutter Cable	1	each				
80-6104-4754-4	Scissors	1	each				
80-6109-3726-2	6955-S Stripper, F/O, JR-11	1	each				
80-6104-4324-6	Cloth Lint Free, 4X4	100	package				
80-6110-0927-7	6355-D Diamond Scoring Tool	1	each				
80-6110-0928-5	6355-A View Scope w/fixture	1	each				

3M™ is a registered trademark of 3M.

ST® is a registered trademark of Lucent Technologies.

### IMPORTANT NOTICE

All statements, technical information and recommendations related to the Seller's products are based on information believed to be reliable, but the accuracy or completeness thereof is not guaranteed. Before utilizing the product, the user should determine the suitability of the product for its intended use. The user assumes all risks and liability whatsoever in connection with such use.

Any statements or recommendations of the Seller which are not contained in the Seller's current publications shall have no force or effect unless contained in an agreement signed by an authorized office of the Seller. The statements contained herein are made in lieu of all warranties, expressed or implied, including but not limited to the implied warranties of merchantability and fitness for a particular purpose which warranties are hereby expressly disclaimed.

SELLER SHALL NOT BE LIABLE TO THE USER OR ANY OTHER PERSON UNDER ANY LEGAL THEORY, INCLUDING BUT NOT LIMITED TO NEGLIGENCE OR STRICT LIABILITY, FOR ANY INJURY OR FOR ANY DIRECT, INDIRECT, INCIDENTAL OR CONSEQUENTIAL DAMAGES SUSTAINED OR INCURRED BY REASON OF THE USE OF ANY OF THE SELLER'S PRODUCTS.



Telecom Systems Division  
6801 River Place Blvd.  
Austin, TX 78726-9000  
<http://www.3M.com/telecom>



Printed on 50% recycled paper  
with 10% post-consumer

Litho in USA  
©3M 1998 78-8073-7873-8